

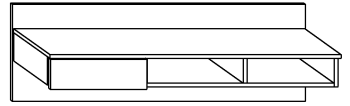

UNO - BIURKO

► 121 ▲ 40 ▼ 40



x 18



(a)

x 6



(b)

x 12



(c)

x 12



(d)

x 1 kpl. (350 mm)

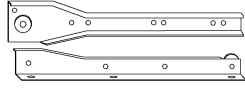

(e)

x 2



(f)

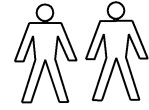

30 min

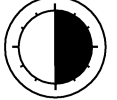

x 4

(3,5x30)



(g)

x 12

(3,5x16)



(h)

x 10

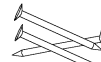

(i)

x 1



(j)



① - FAZY MONTAŻU

Ⓐ - OZNACZENIE ELEMENTÓW

Ⓐ - OZNACZENIE AKCESORIÓW

①

x 2



(b)

x 4



(c)

x 1 kpl.



(e)

x 8

(3,5x16)



(h)

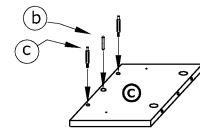
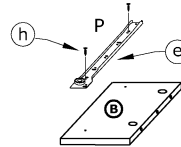
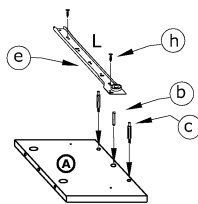

②

x 4



(b)

x 8



(c)

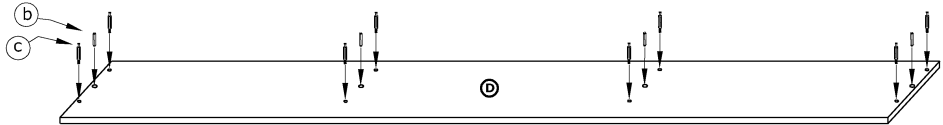

③

x 4



(a)

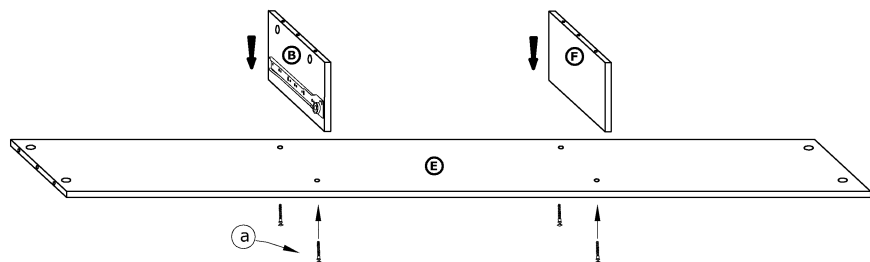

④

x 4



(d)



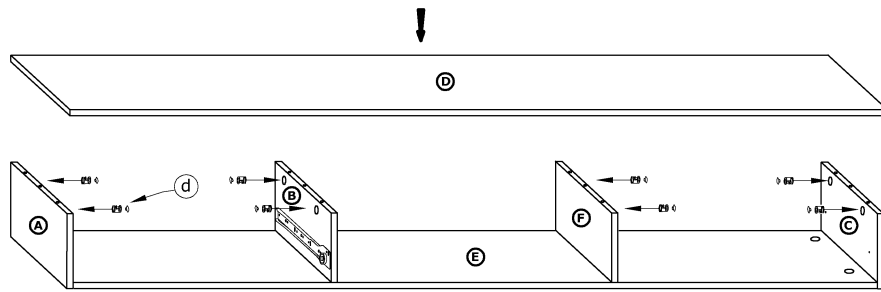

5 x 8

 d

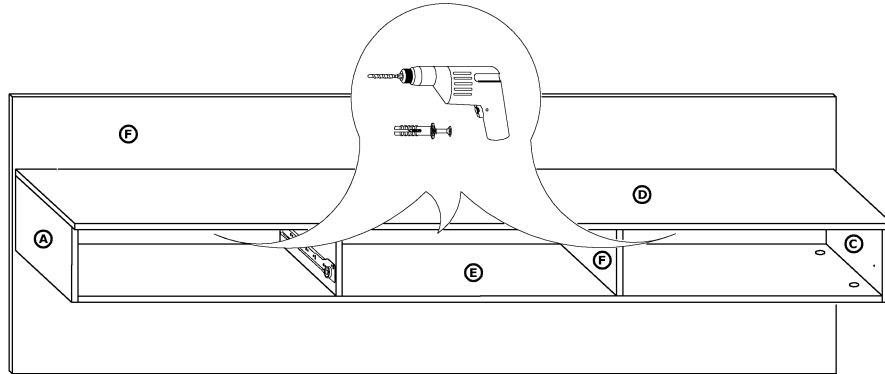
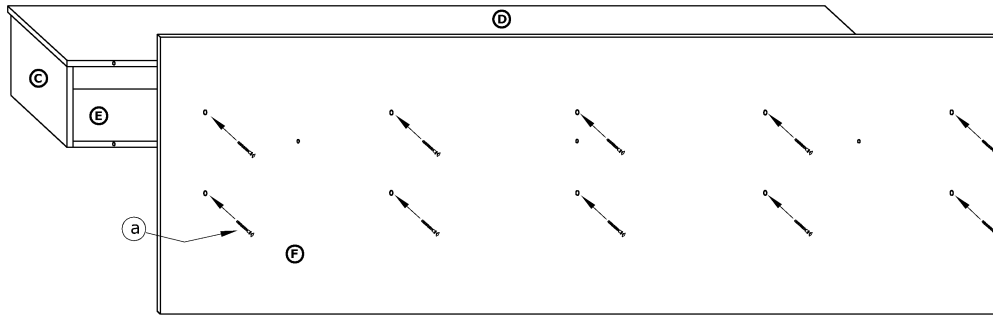



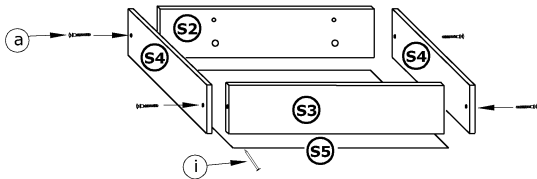

6 x 10

 a

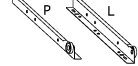

7 x 4 x 10
 
 a i

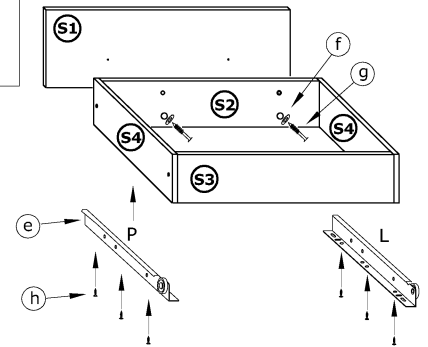

8 x 1 kpl. x 2
 
 e f
 x 2 x 6
 (3,5x30) (3,5x16)
 
 g h



9 x 2
 (3,5x30)

 g

