

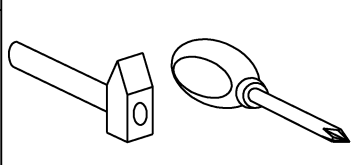

SOL-03
SOLO - ŁAWA
 ➔ 80 ↑ 52 ↘ 80

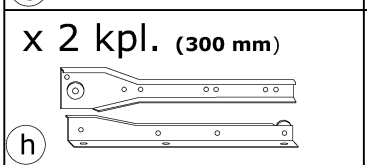
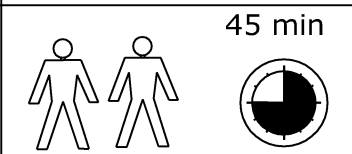
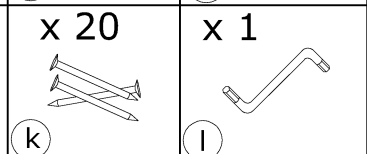
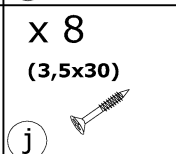
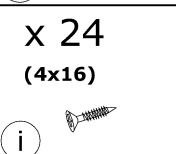
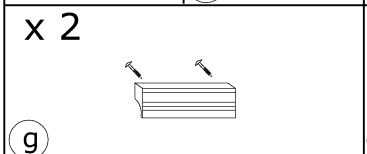
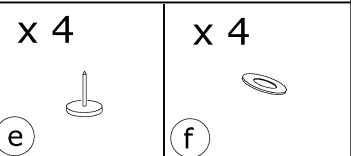
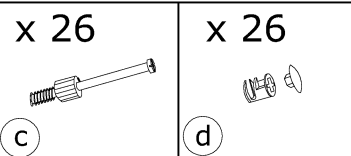
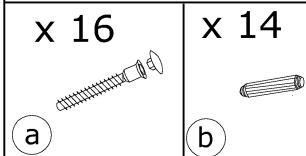
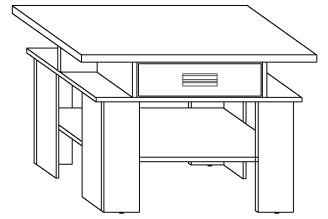

① - FAZY MONTAŻU

Ⓐ - OZNACZENIE ELEMENTÓW

ⓐ - OZNACZENIE AKCESORIÓW

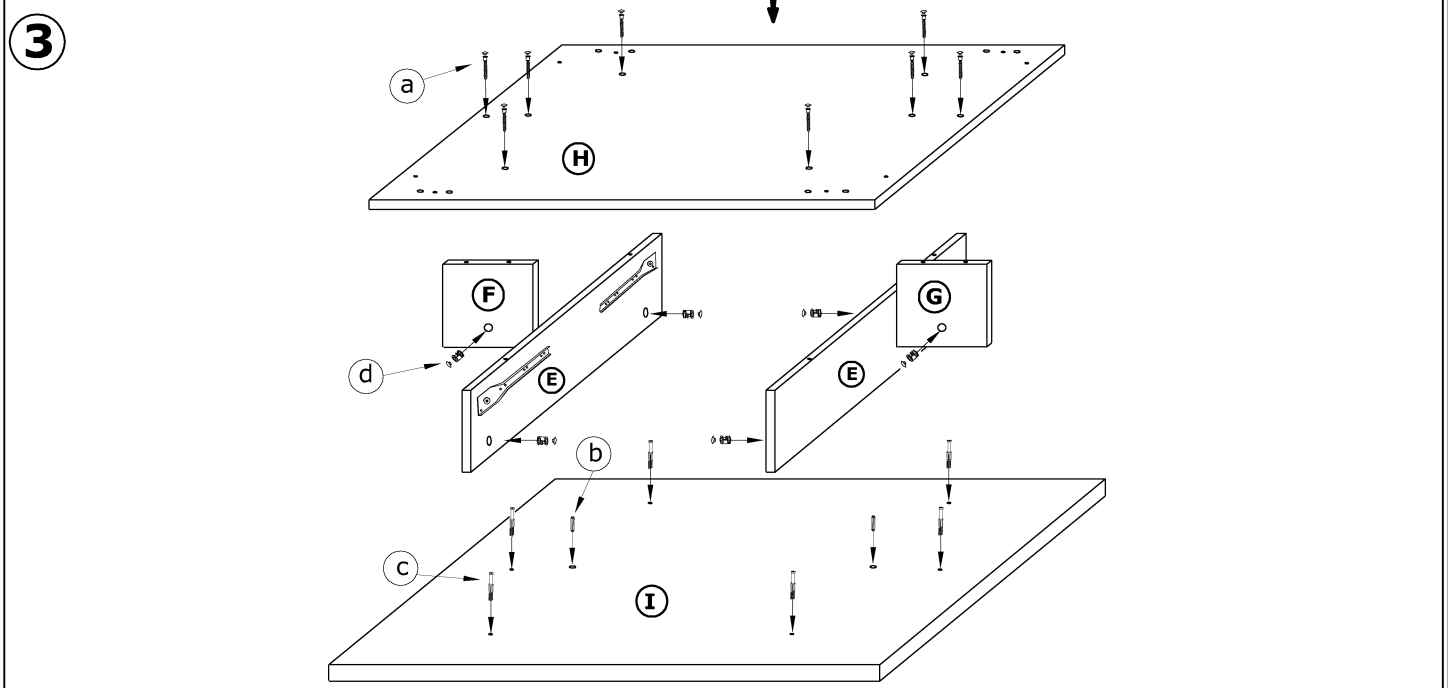
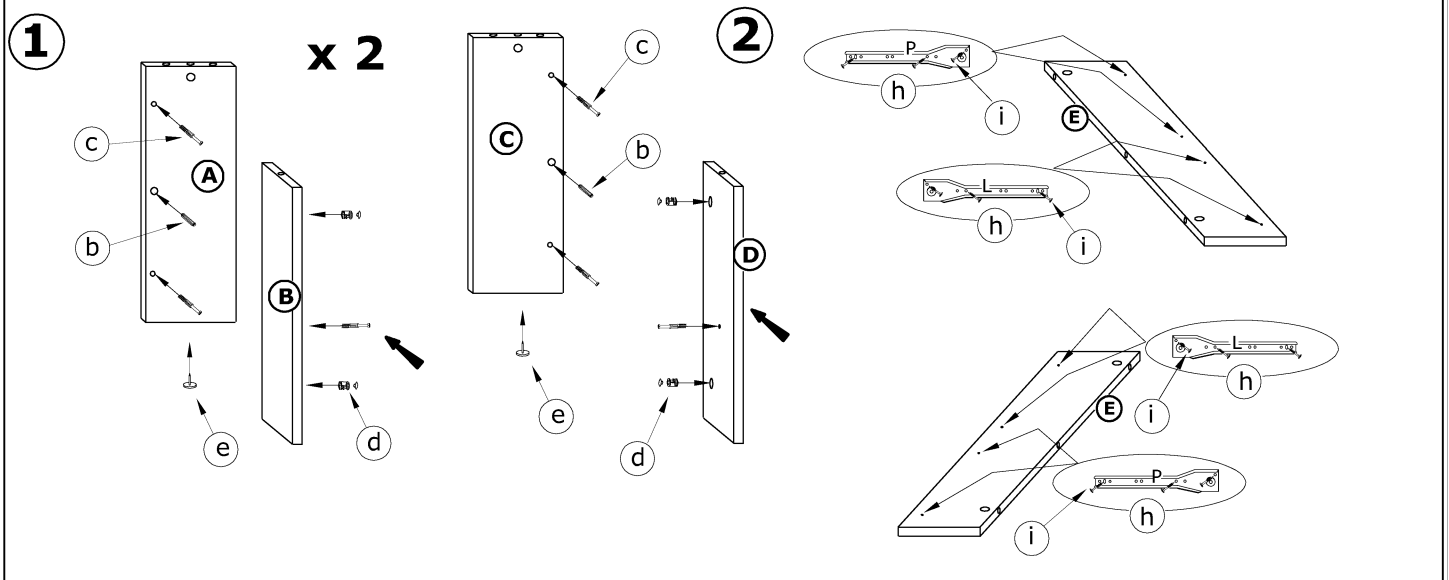

4

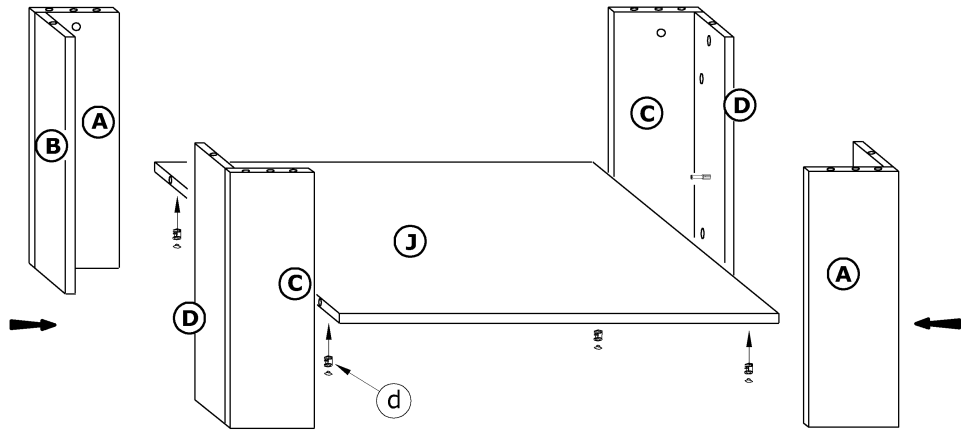

5

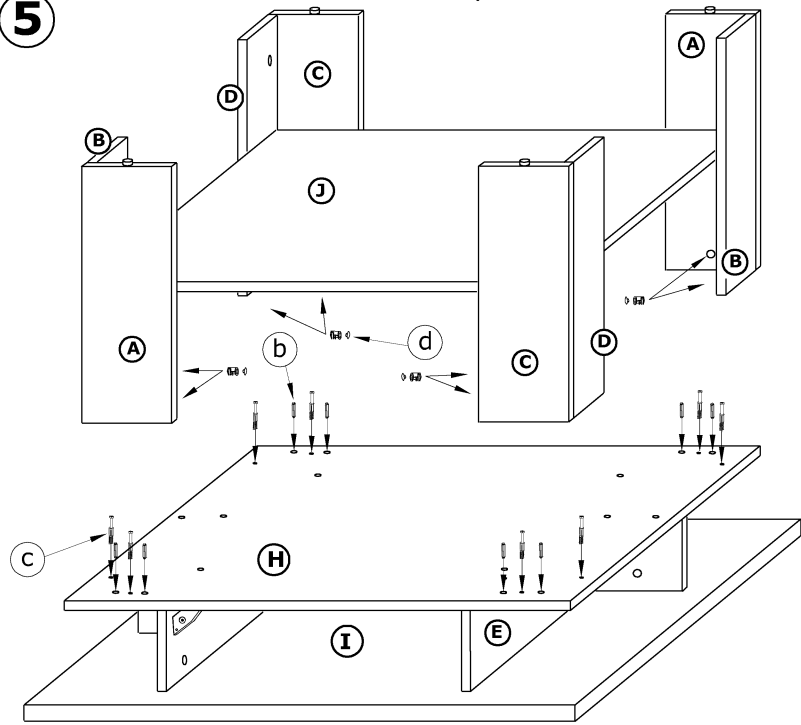

6

X 2

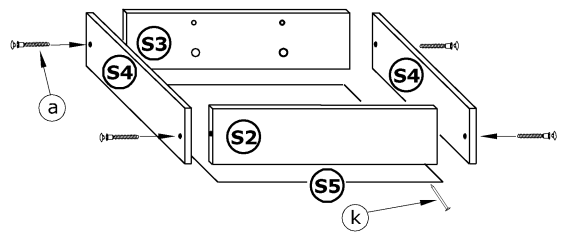

7

X 2

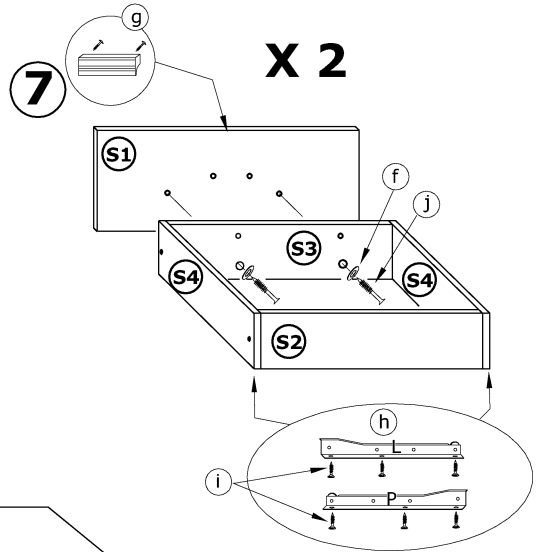

8

