

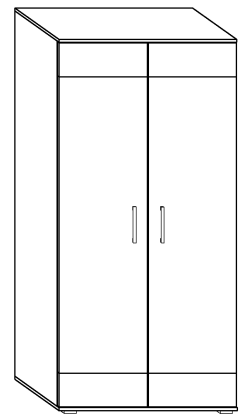

SLR-05 SOLAR - SZAFKA

→ 90 ↑ 190 ↘ 52



x 4



a

x 6

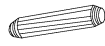

b

x 12

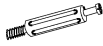

c

x 12



d

x 6

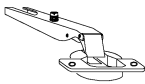

e

x 6

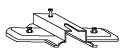

f

x 2



g

x 4

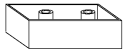

h

x 1 (862 mm)

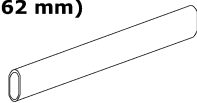

i

x 2



j

45 min

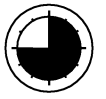
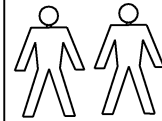

x 8 (4x20)

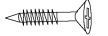

k

x 20 (3,5x16)



l

x 80



m

x 1



n

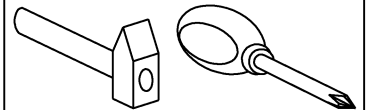

1 - FAZY MONTAŻU

A - OZNACZENIE ELEMENTÓW

a - OZNACZENIE AKCESORIÓW

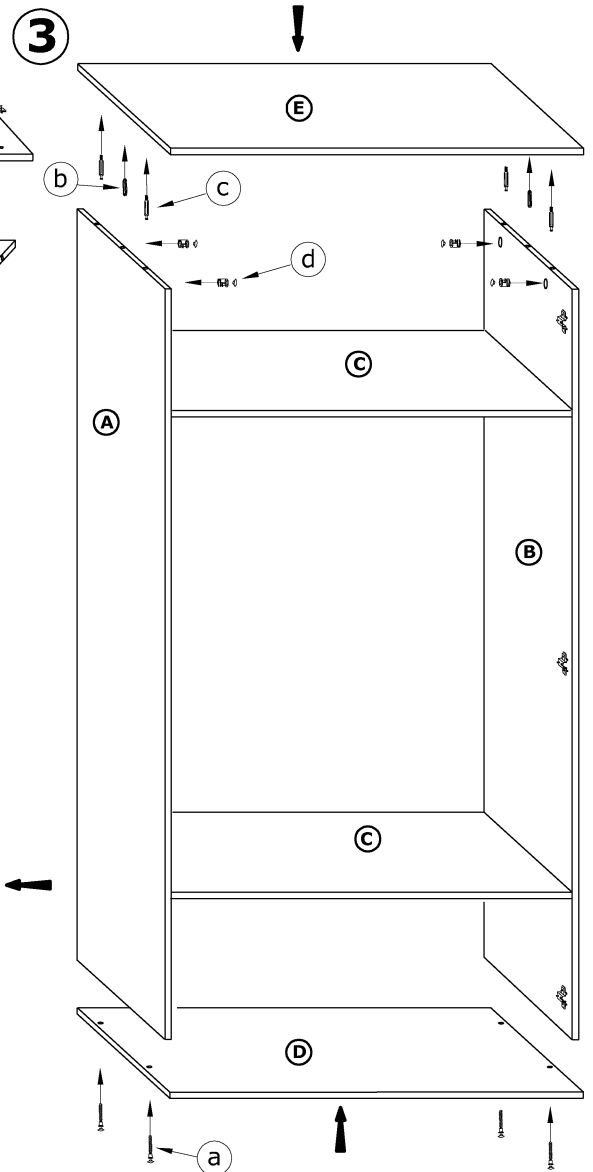
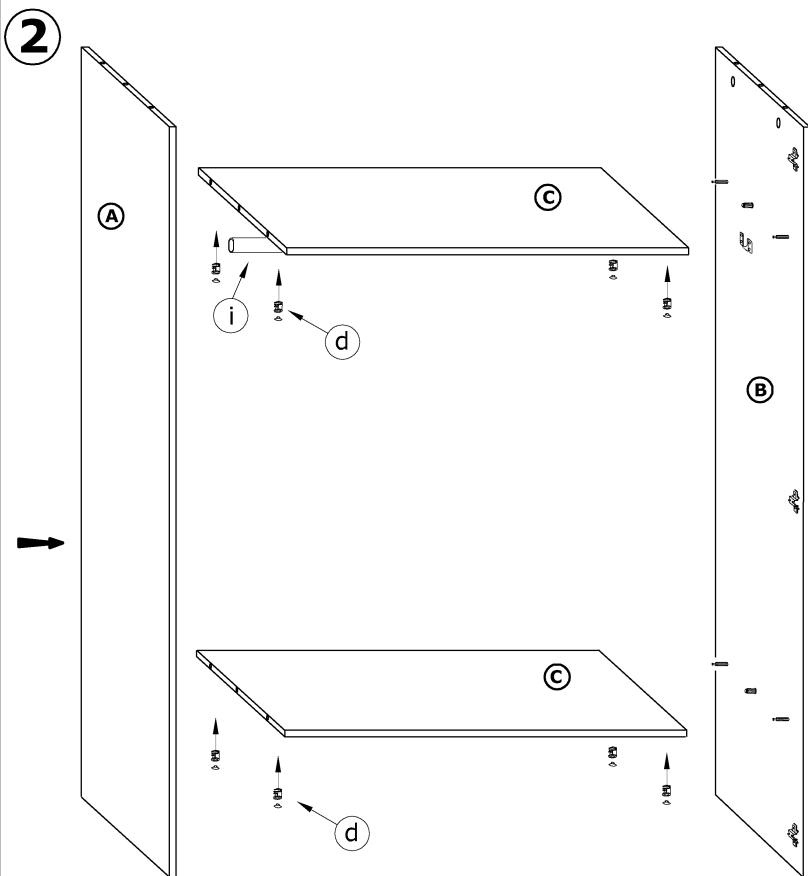
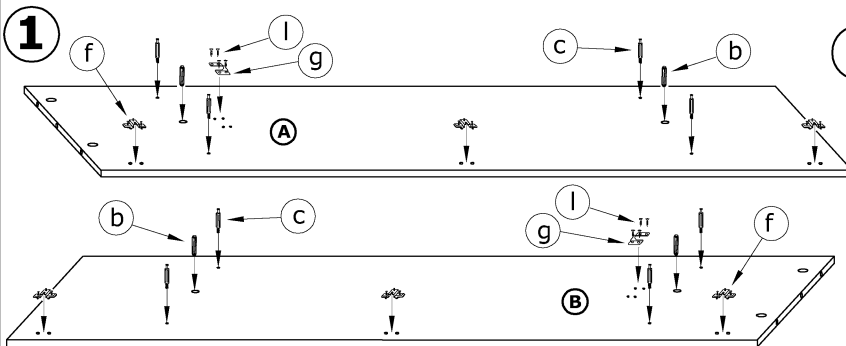

4

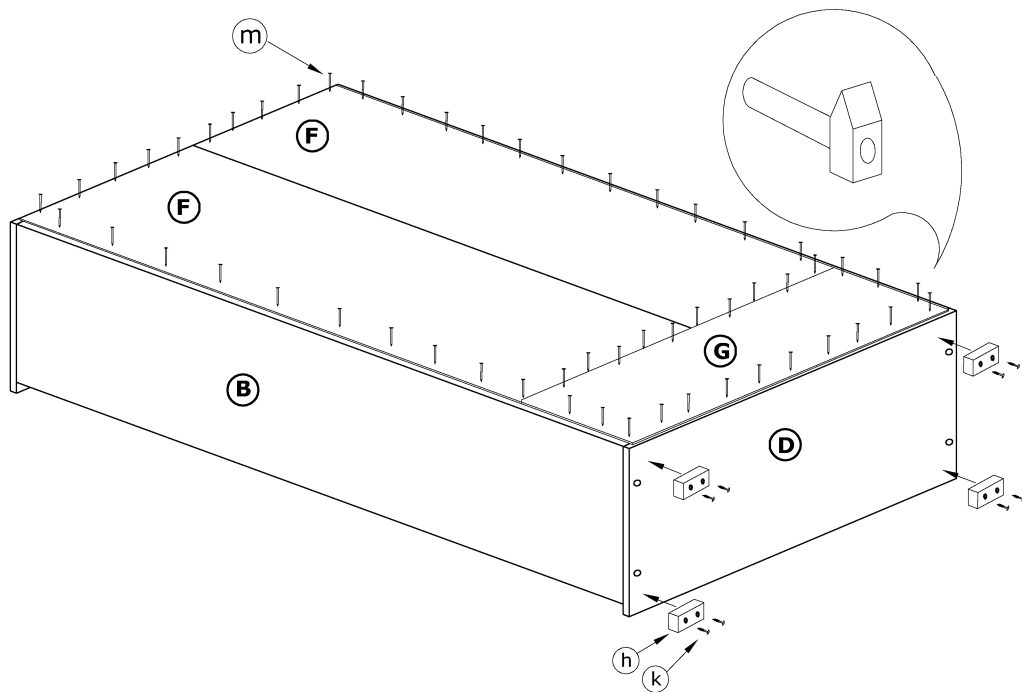

5

