

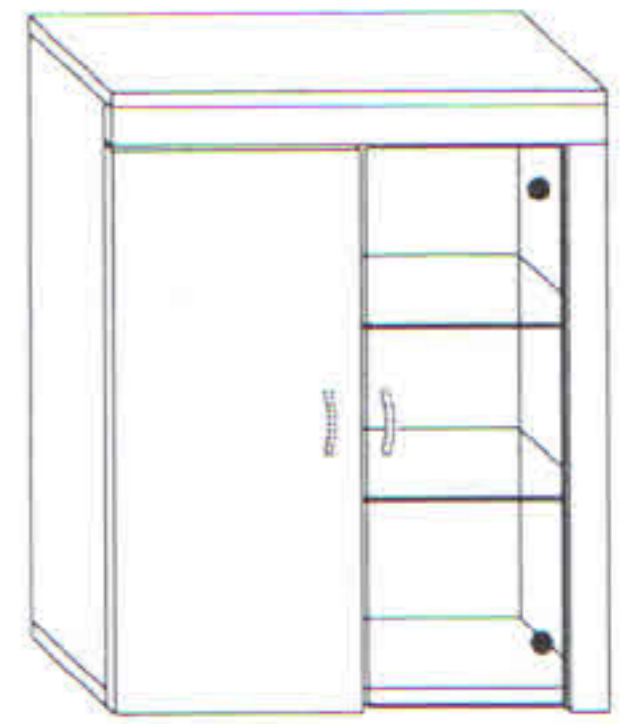









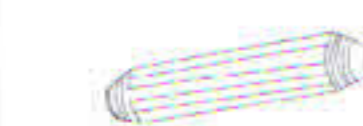



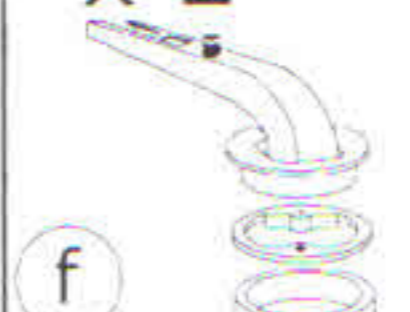
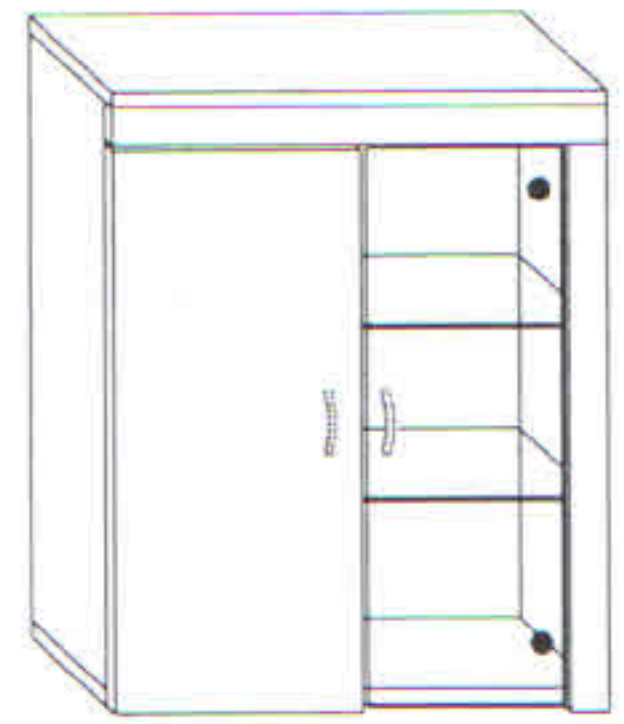

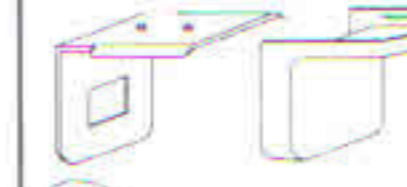
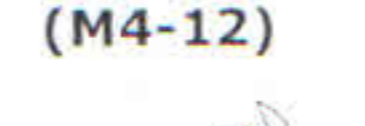
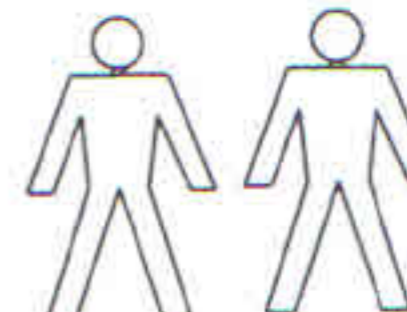

MAMBA SZAFKA WISZĄCA

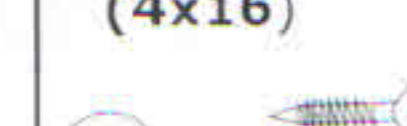
- 90 x 111 x 35



x 12 	x 7 	x 2 	x 2 	x 2 	x 2 	
x 2 	x 3 	x 3 	x 3 kpl. 	x 2 (M4-12) 	 40 min 	
x 6 (6,2x16) 	x 4 (4x16) 	x 16 	x 60 	x 1 	x 1 	

1 - FAZY MONTAŻU

A - OZNACZENIE ELEMENTÓW

a - OZNACZENIE AKCESORIÓW

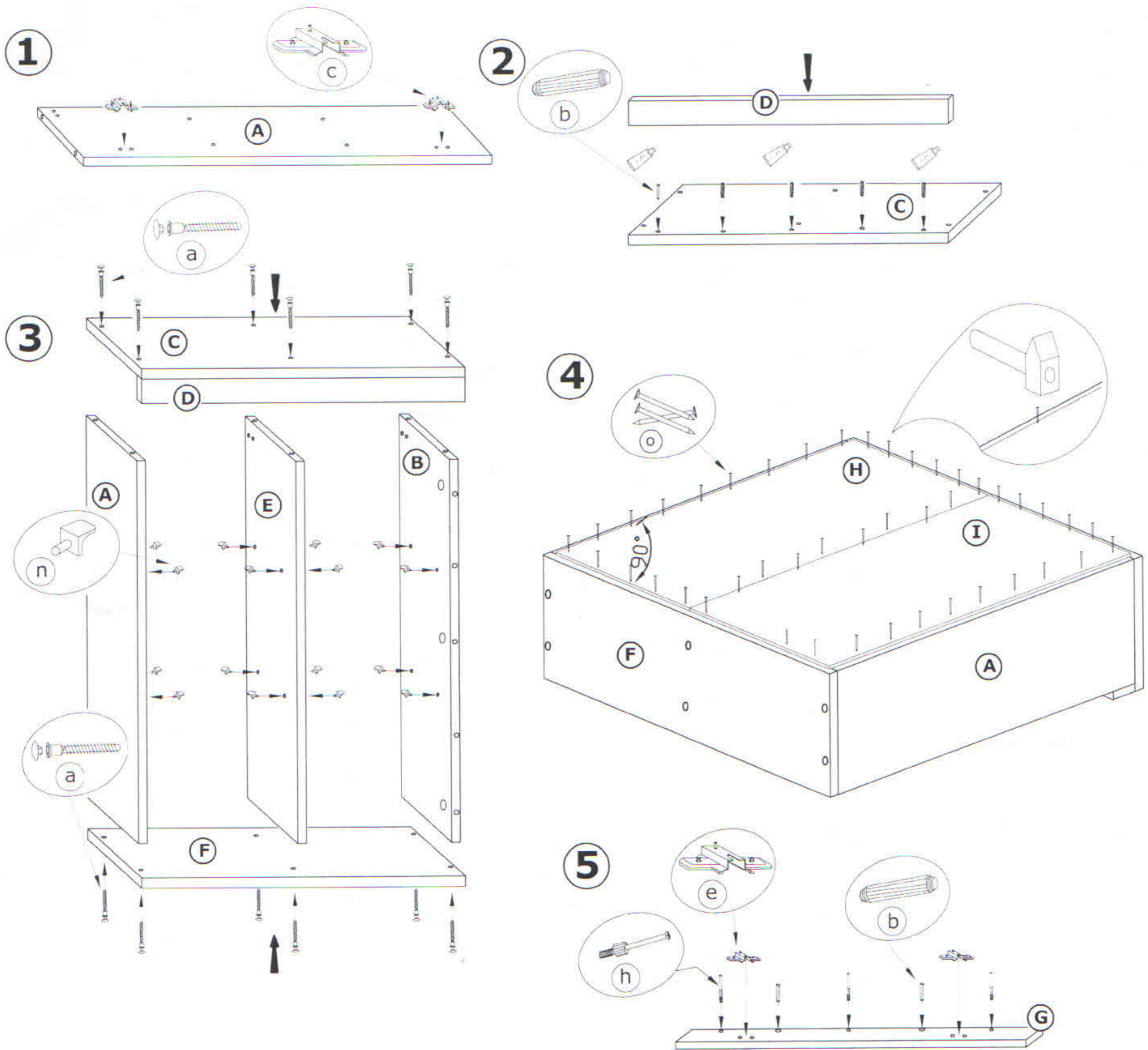

6

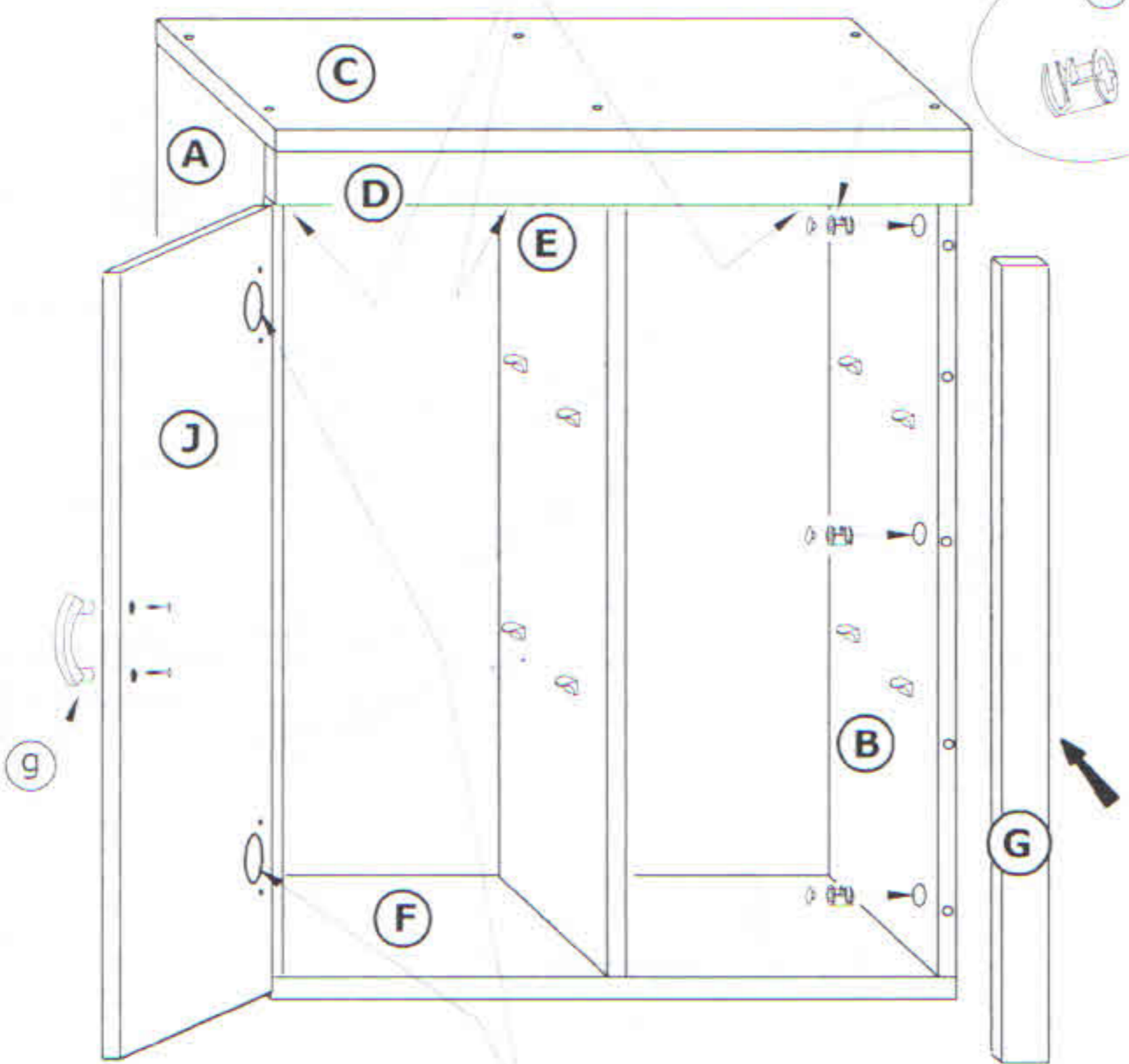
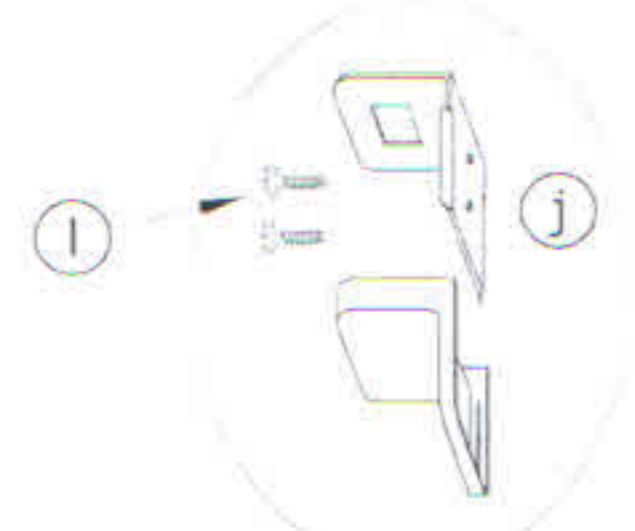

7

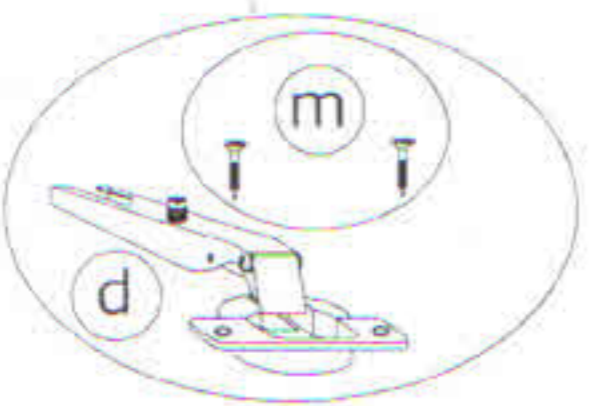
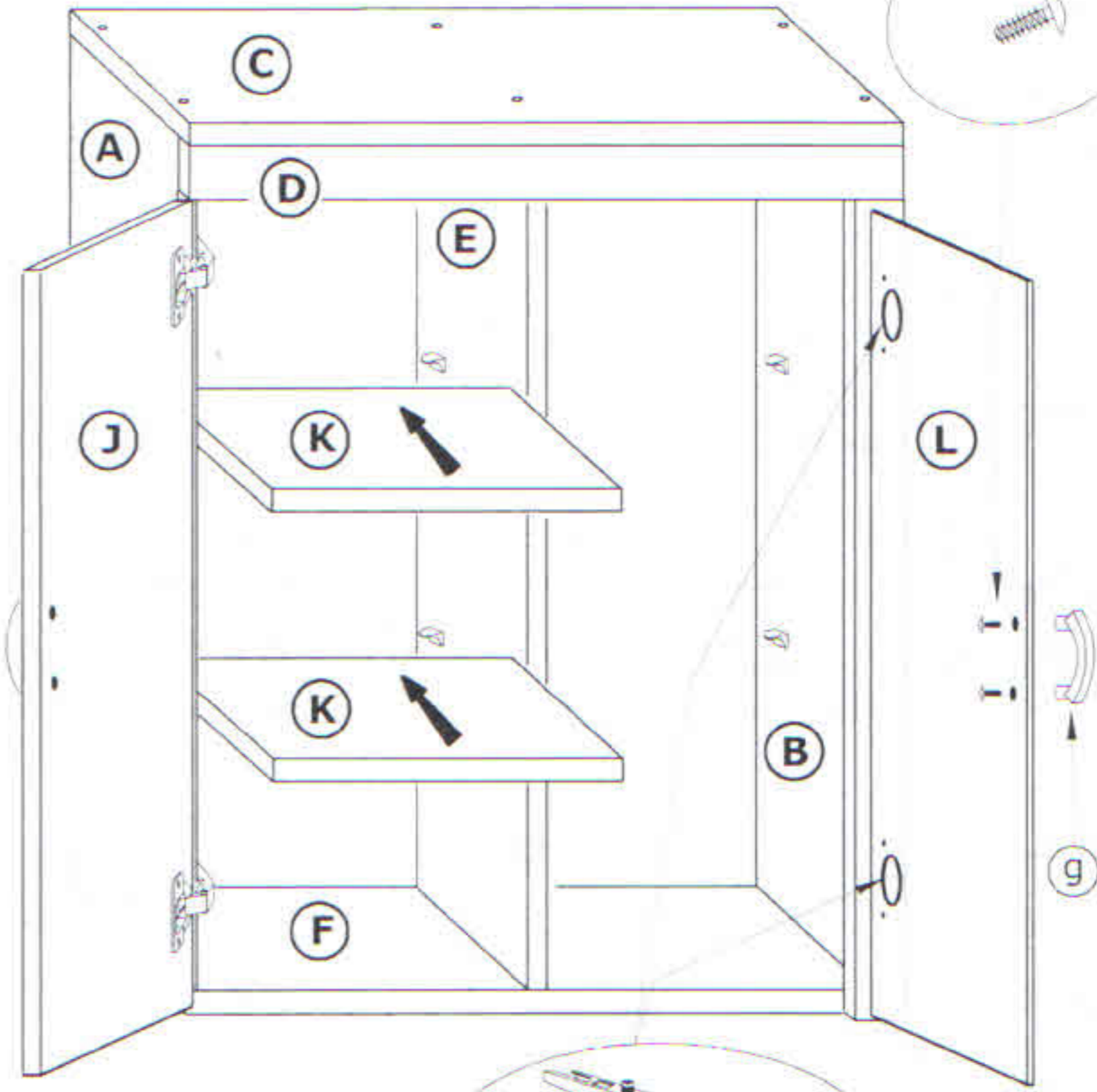
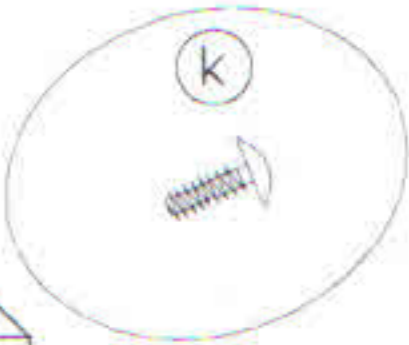

8

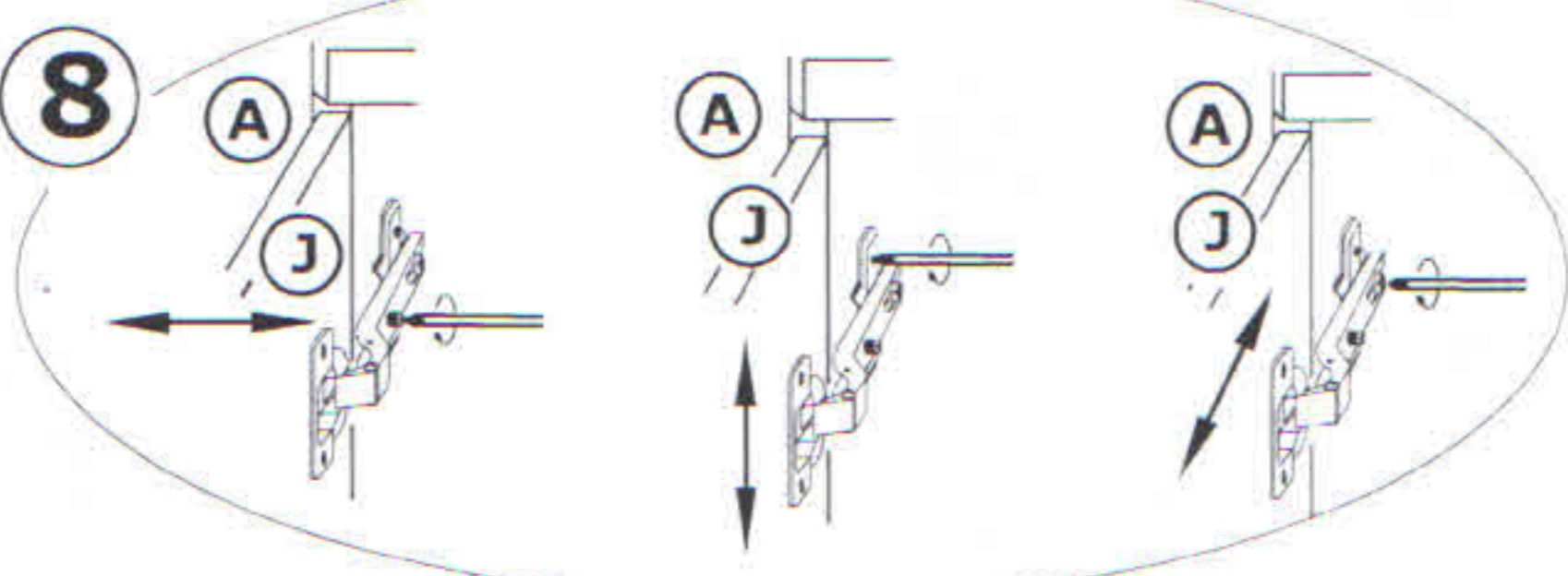

9

