

MAGIC-ŁAWA

→ 80 × 48 × 80

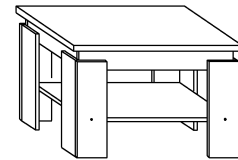

x 4



x 20



x 4



(a)

(b)

(c)

x 16

4x30



x 1



x 1

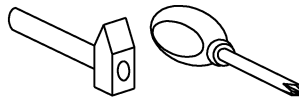
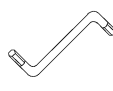

(d)

(e)

(f)

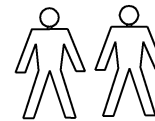

30 min

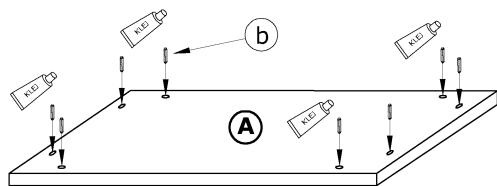
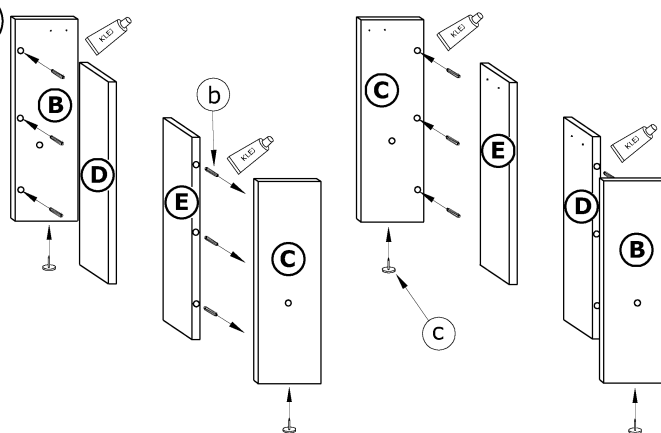
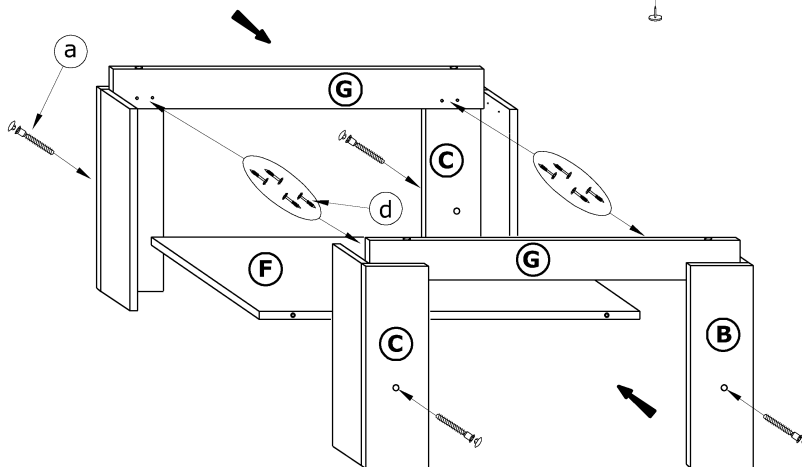
**1** - FAZY MONTAŻU**A** - OZNACZENIE ELEMENTÓW**a** - OZNACZENIE AKCESORIÓW**1****2****3****4**