

FOX

→ 139 | 42 | 36

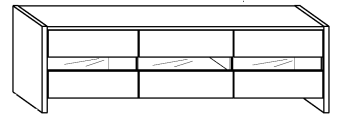

x 6 a	x 4 b	x 12 c	x 12 d	x 2 e	x 4 f	
x 6 g	x 3 h	x 3 i	x 4 j	x 18 k	x 2 l	 40 min
x 16 (3,5x16) n	x 18 (3x20) o	x 4 p	x 60 r	x 1 s		



① - FAZY MONTAŻU

Ⓐ - OZNACZENIE ELEMENTÓW

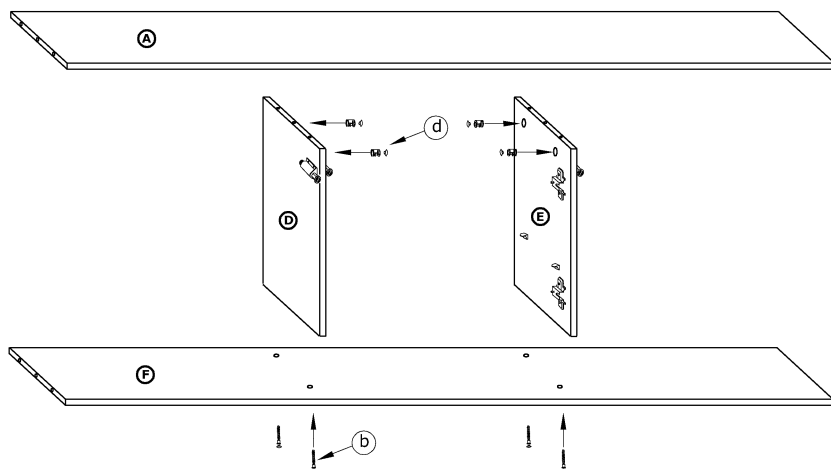
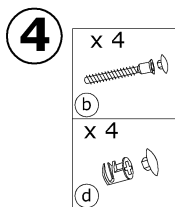
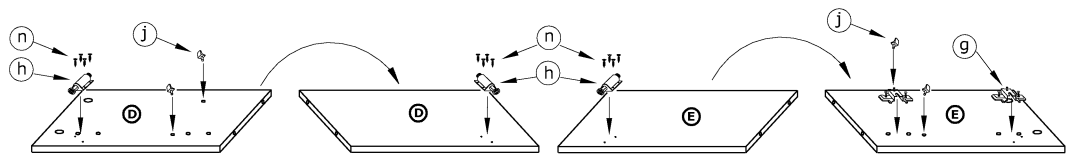
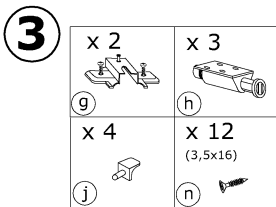
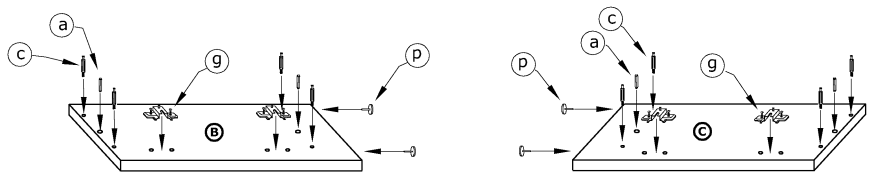
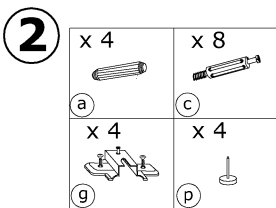
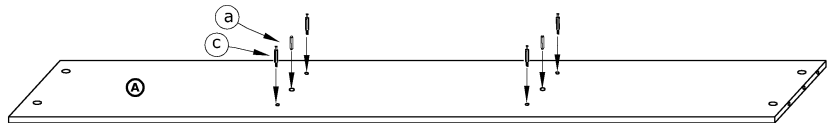
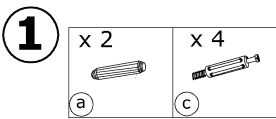
Ⓐ - OZNACZENIE AKCESORIÓW



5

- x 8

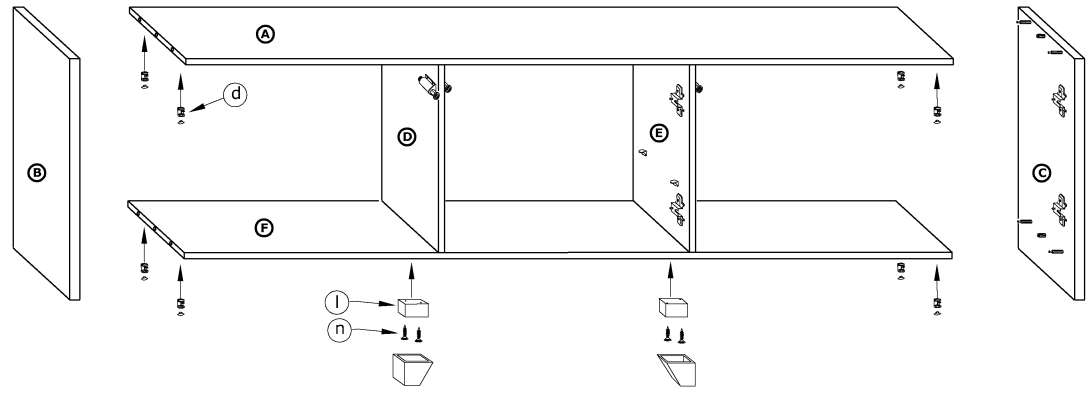
- x 2

- x 4
(3,5x16)



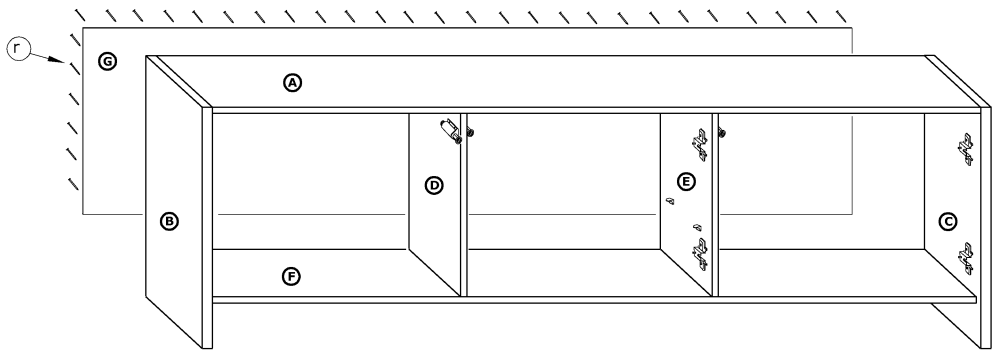





6

- x 60



7

- | | | |
|---|---|--|
| x 2
 | x 4
 | x 3
 |
| x 18
 | x 18
(3,5x16)
 | |
| x 18
(3x20)
 | | |

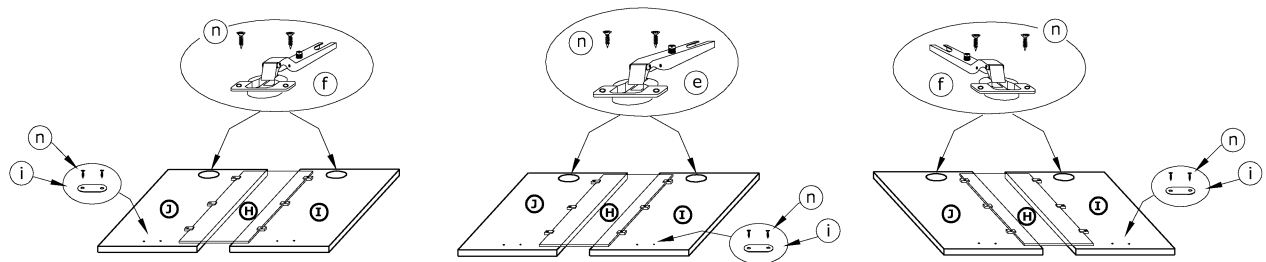
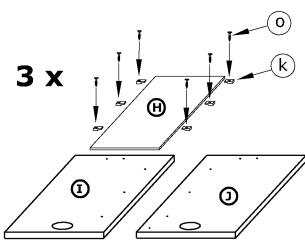

8

