

MAMBA-ŁAWA

→ 120 × 48 × 60

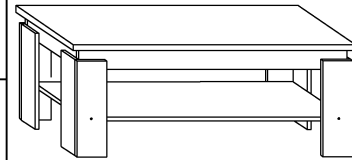

x 4



(a)

x 22



(b)

x 4



(c)

x 16

4x30



(d)

x 1



(e)

x 1

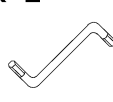

(f)

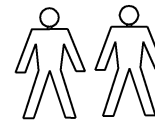
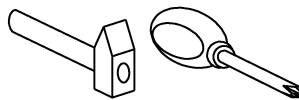

30 min



1 - FAZY MONTAŻU

A - OZNACZENIE ELEMENTÓW

a - OZNACZENIE AKCESORIÓW

1

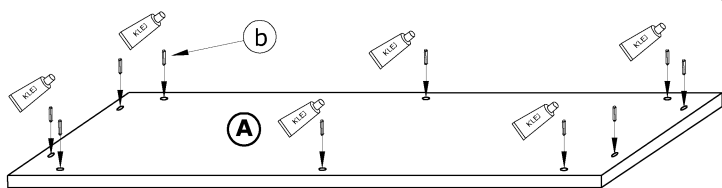

2

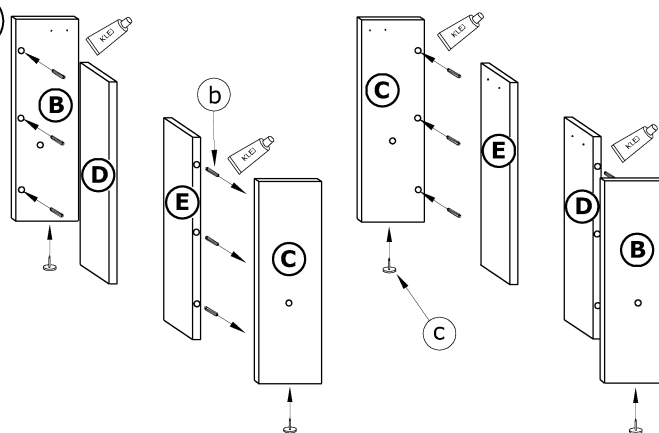

3

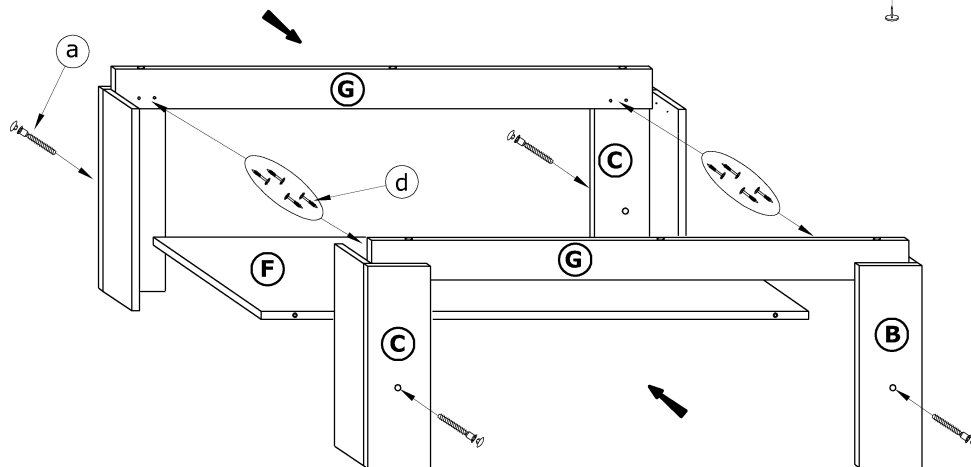

4

