

montážny návod Emio

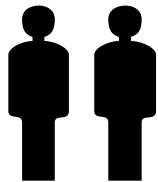

ASSEMBLE DIFFICULTY:
1 2 3 4 5

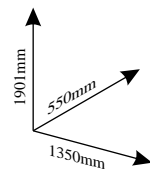

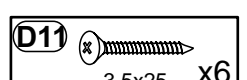
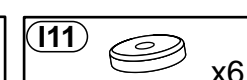
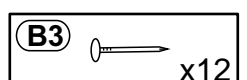
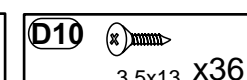
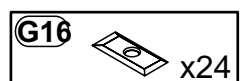
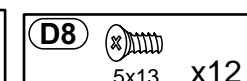
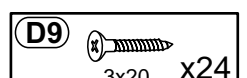
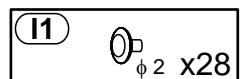
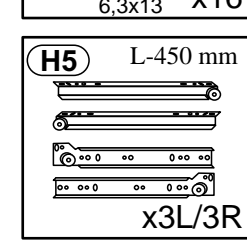
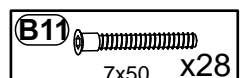
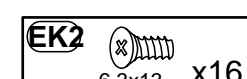
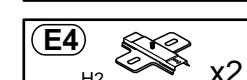
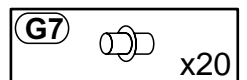
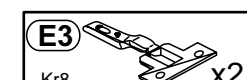
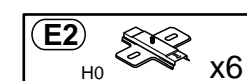
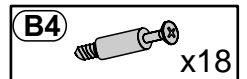
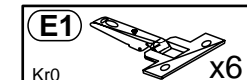
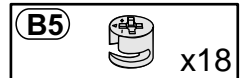
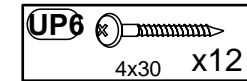
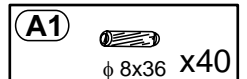
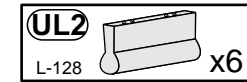
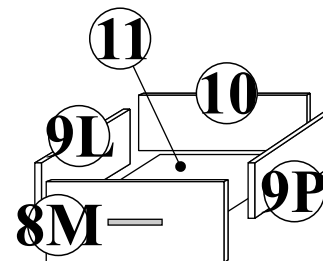
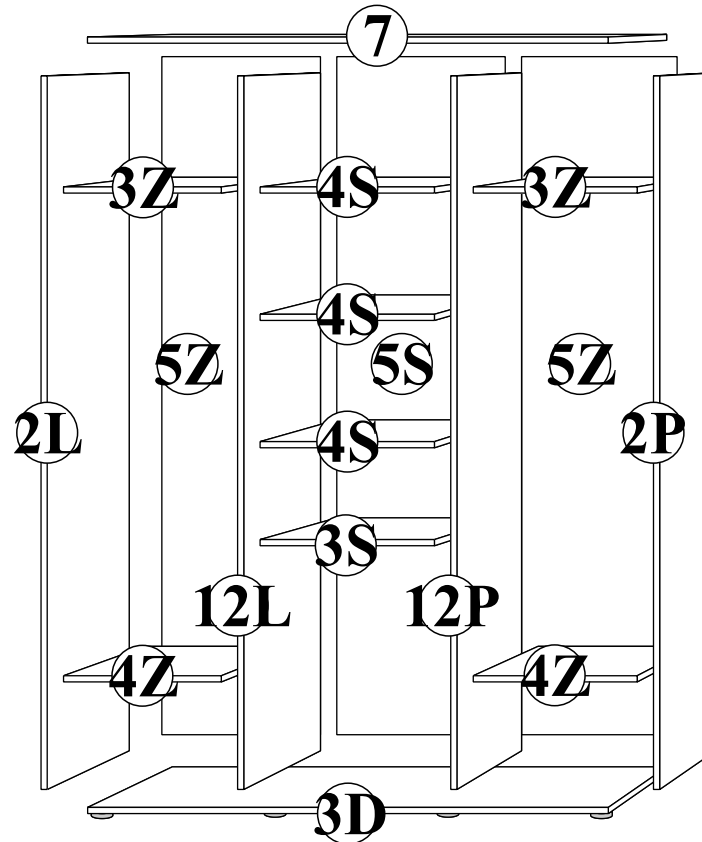
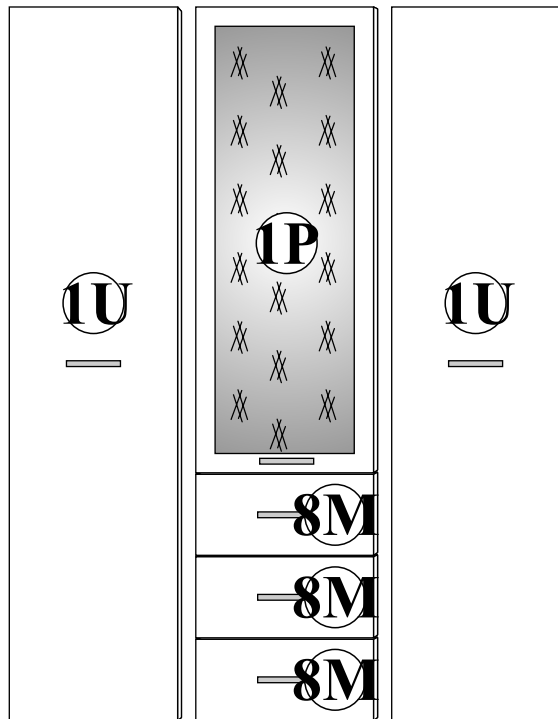
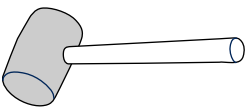
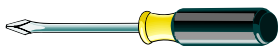
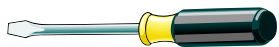
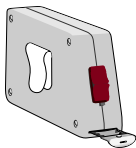

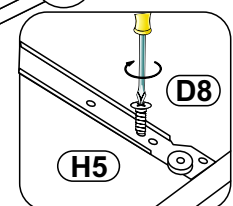
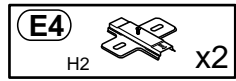
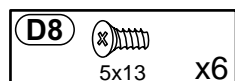
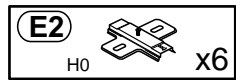
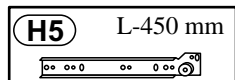
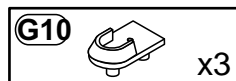
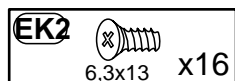
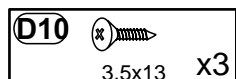
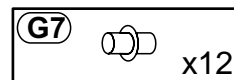
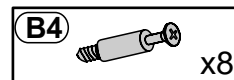
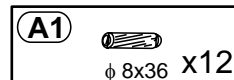
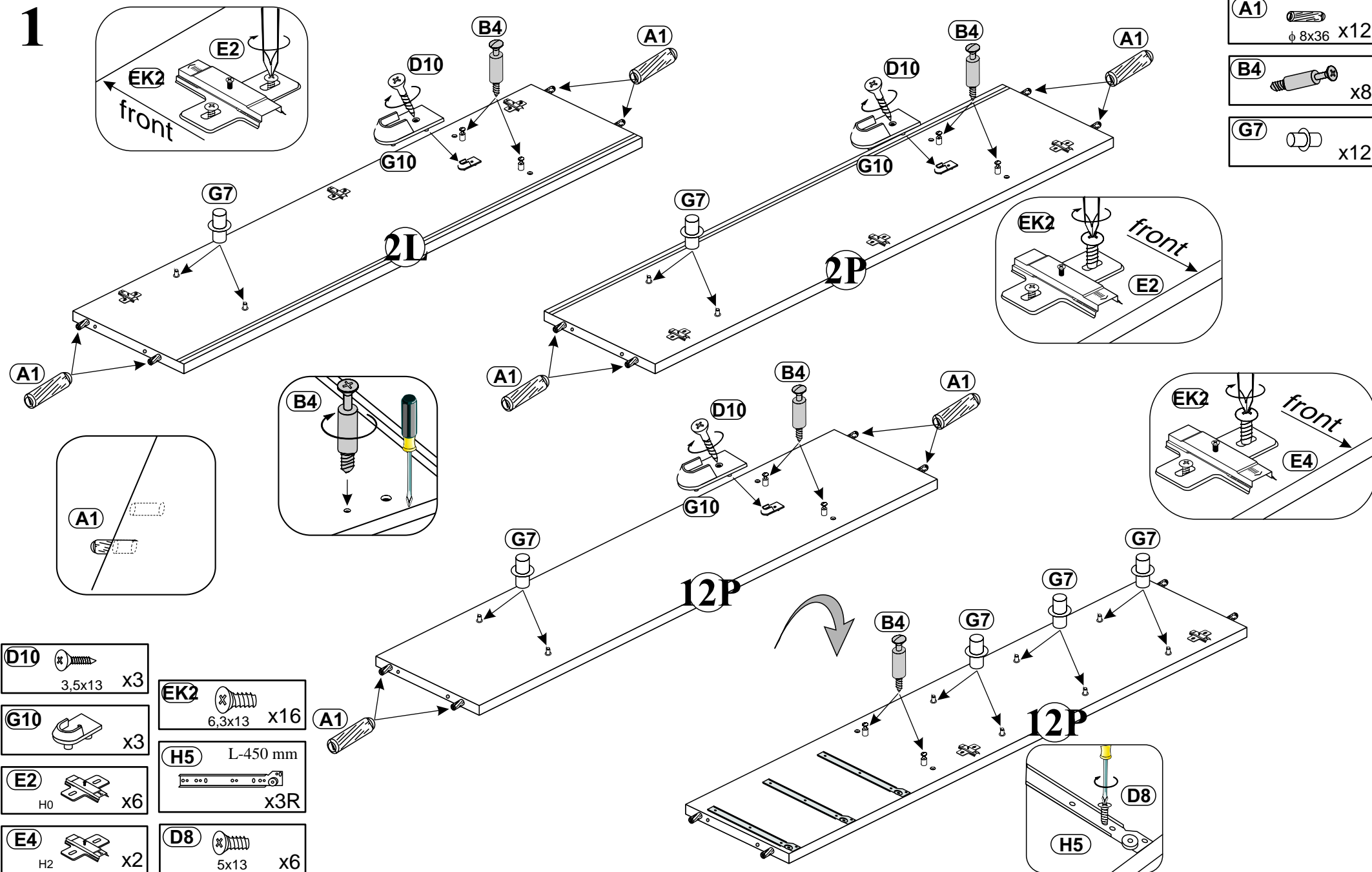



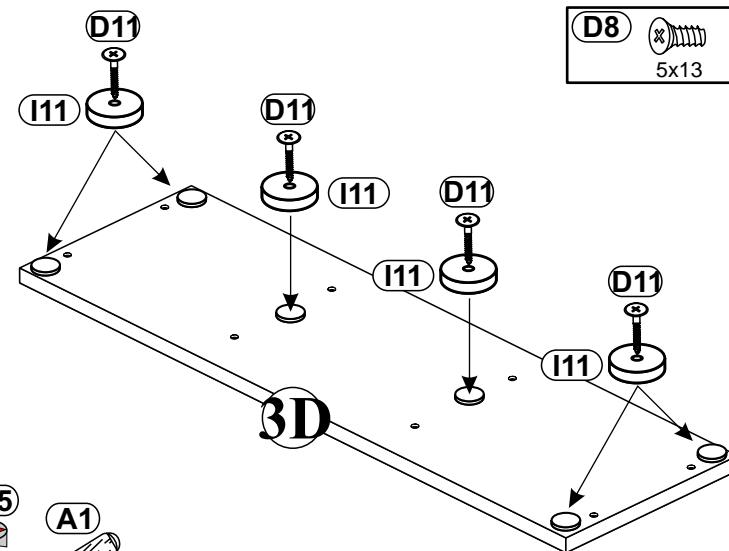
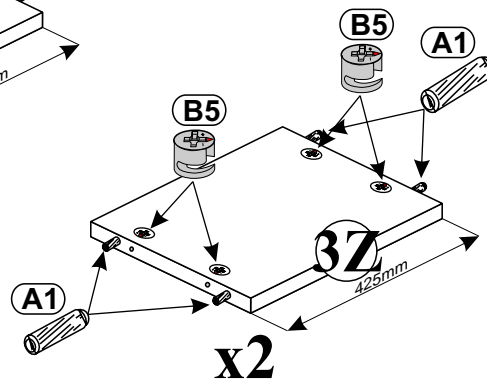
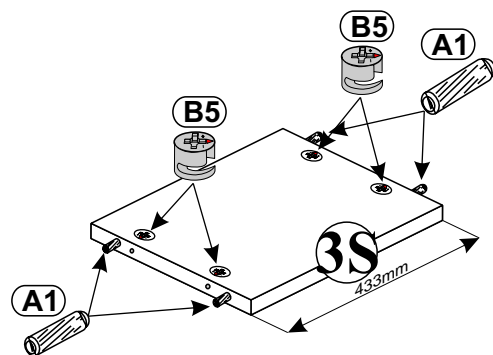
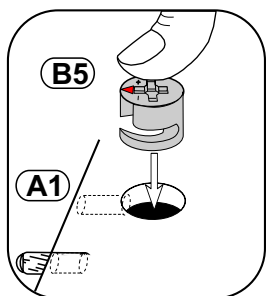
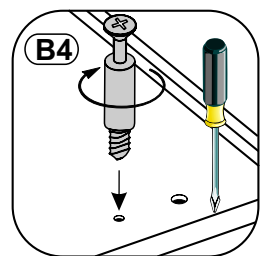
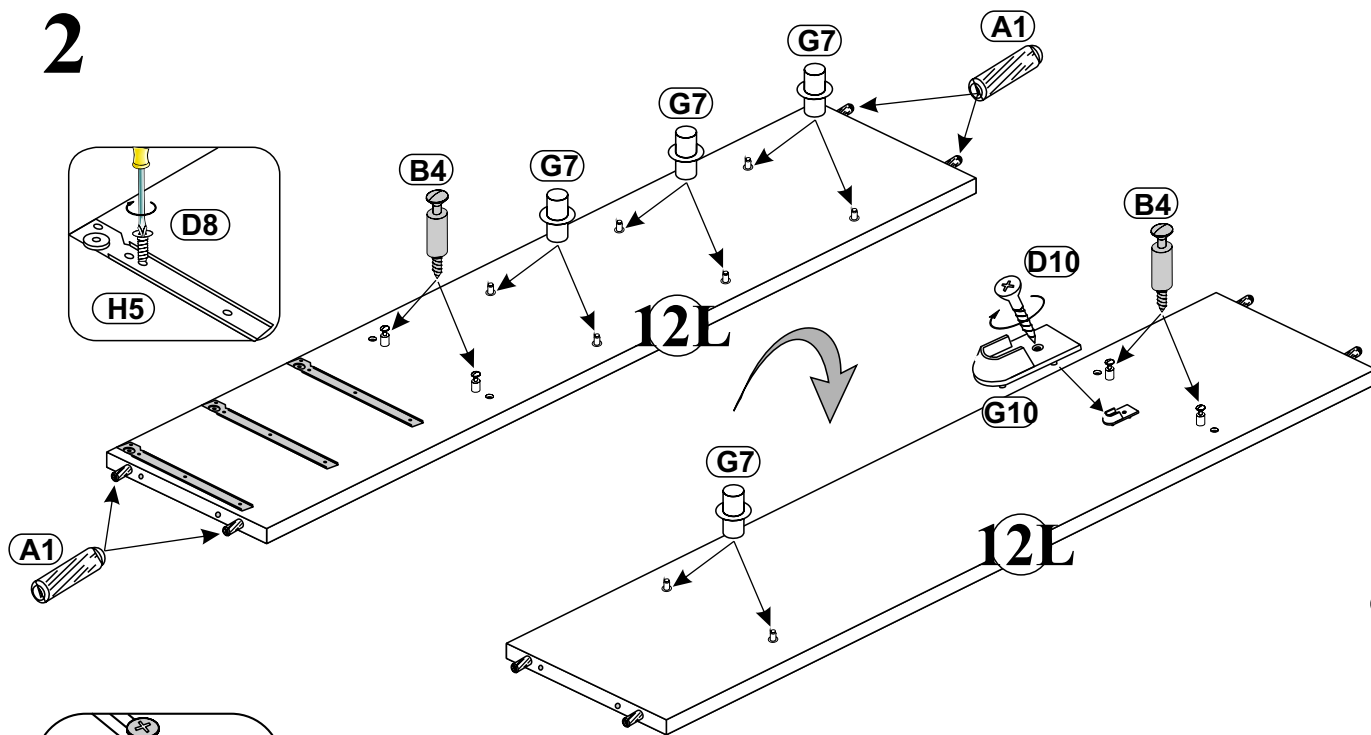



1



2

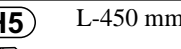

- | | |
|---|---|
| I11  x6 | A1  x16
φ 8x36 |
| D11  x6
3.5x25 | B5  x12 |
| G10  x1 | B4  x4 |
| D10  x1
3.5x13 | G7  x8 |
| H5 L-450 mm
 x3L | |
| D8  x6
5x13 | |

3

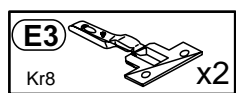
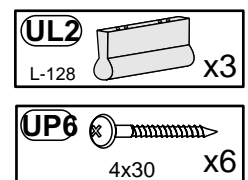
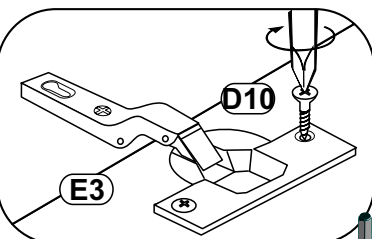
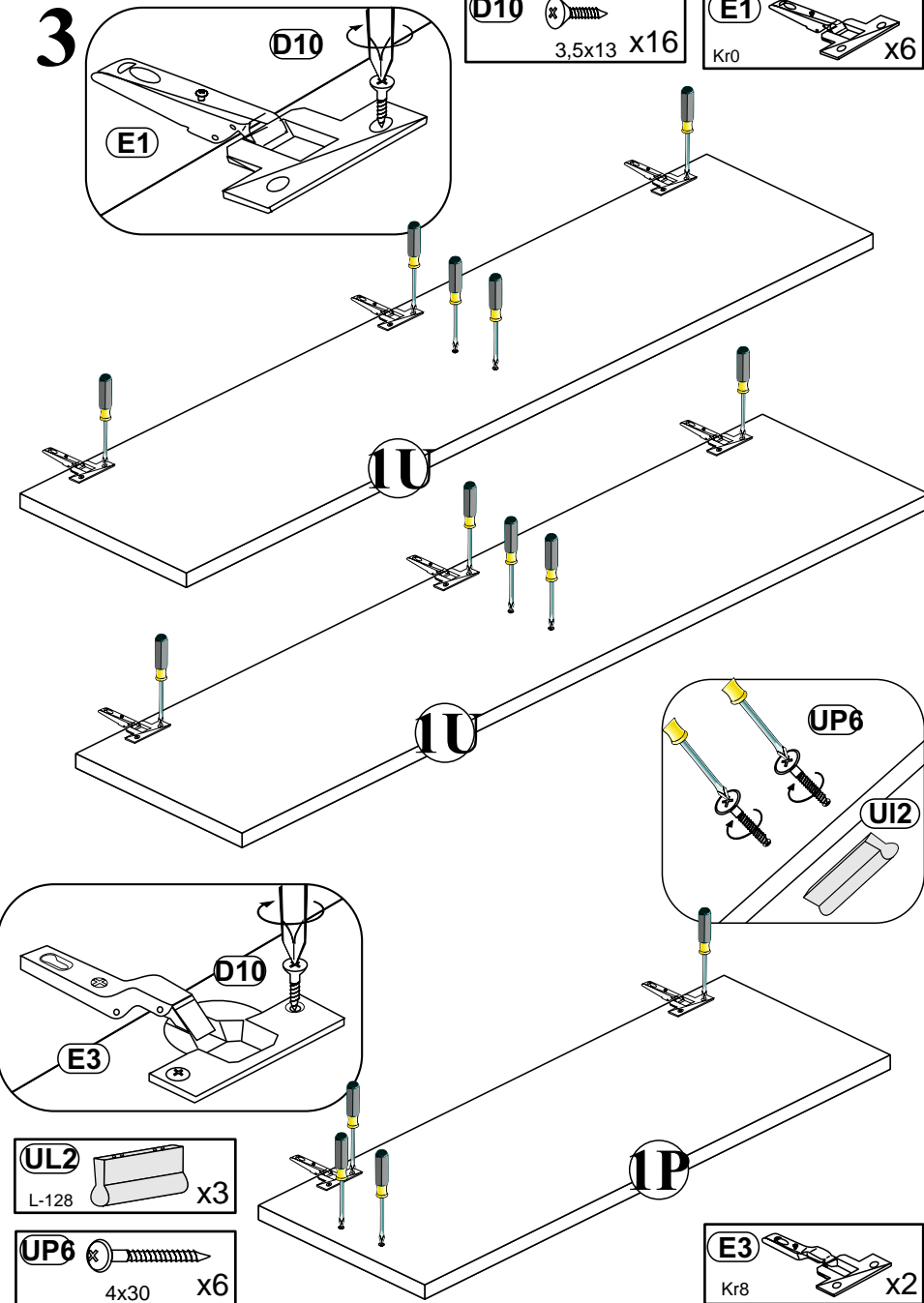
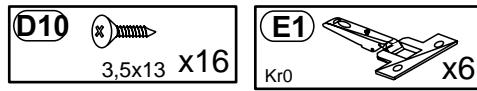

4

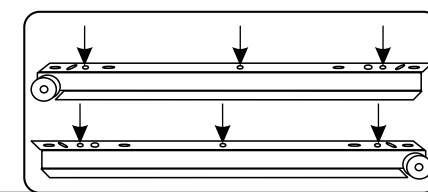
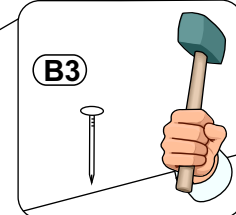
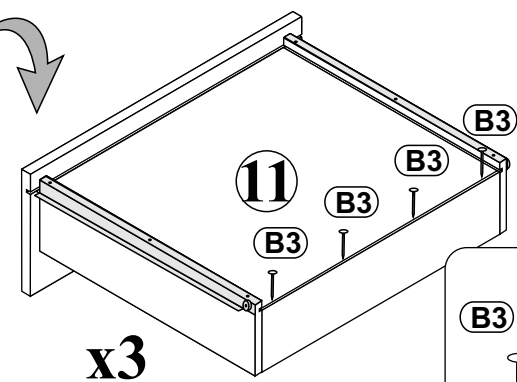
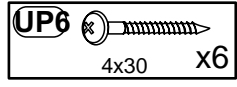
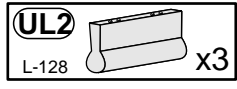
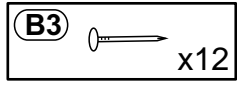
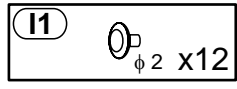
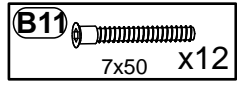
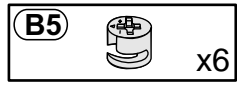
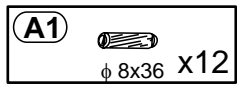
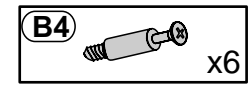
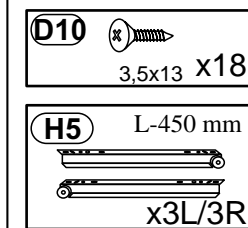
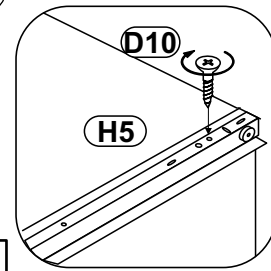
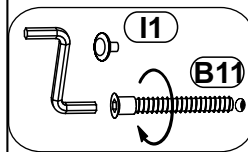
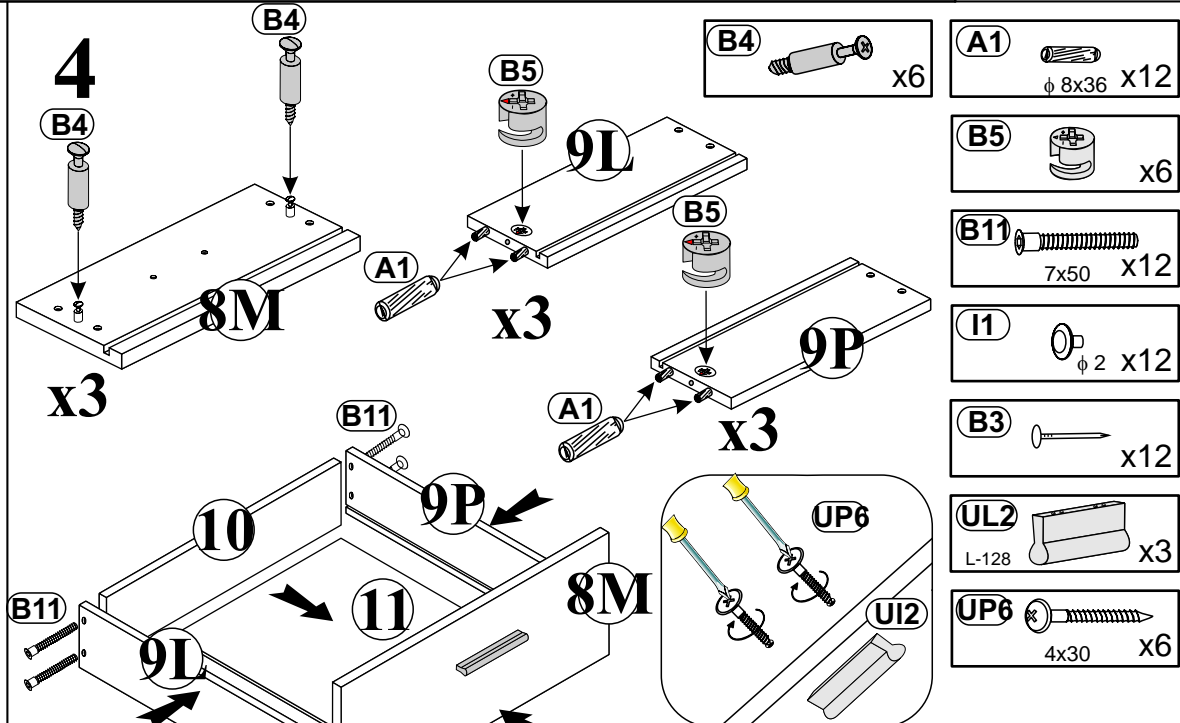

5

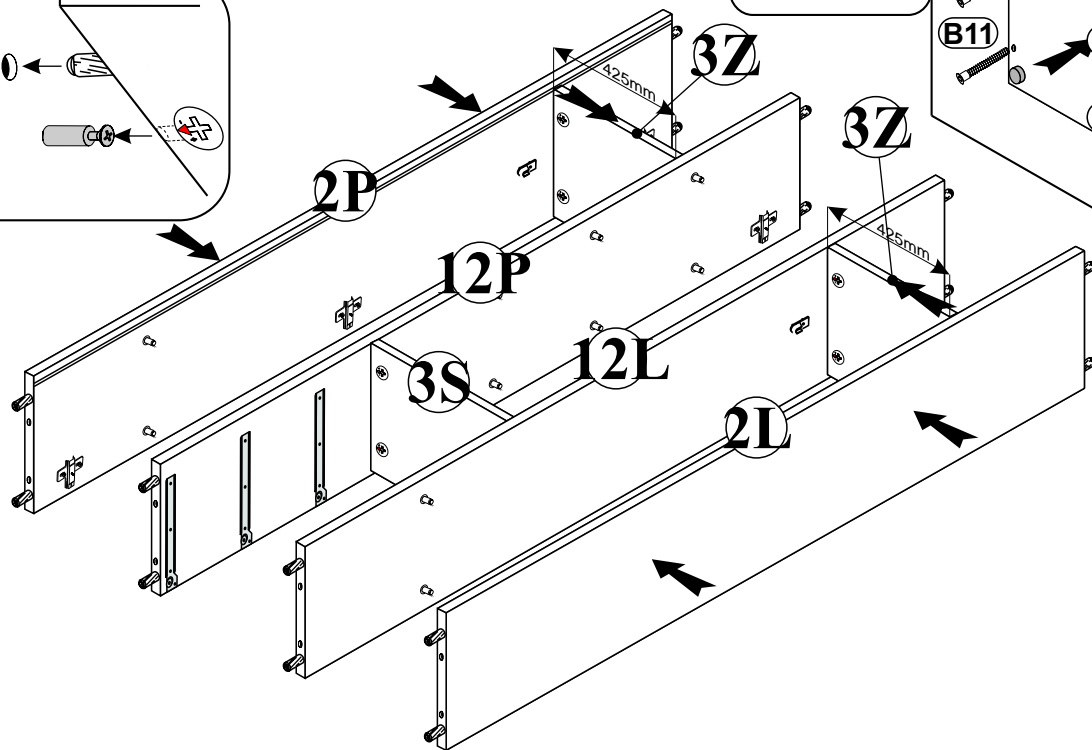
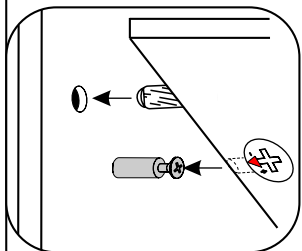
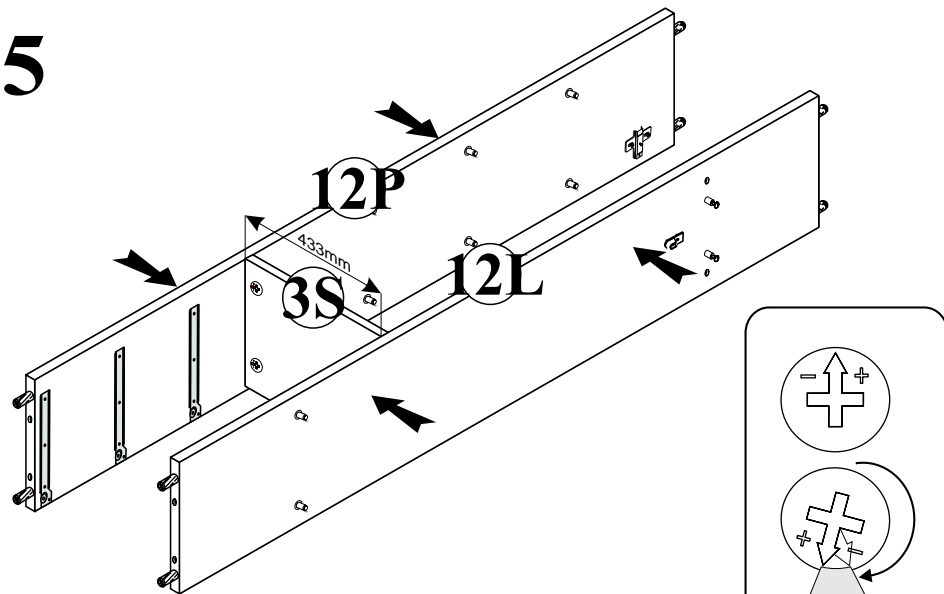

6

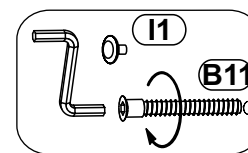
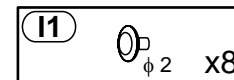
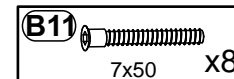
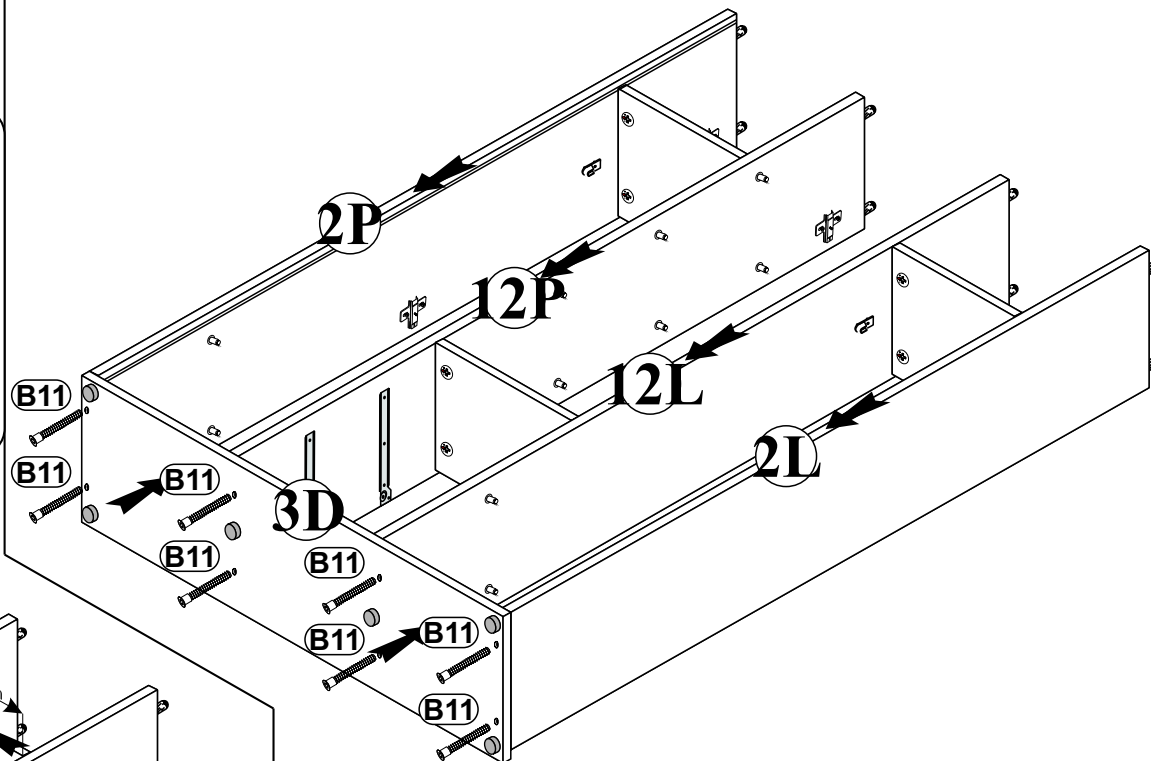

7

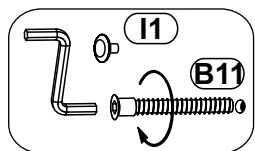
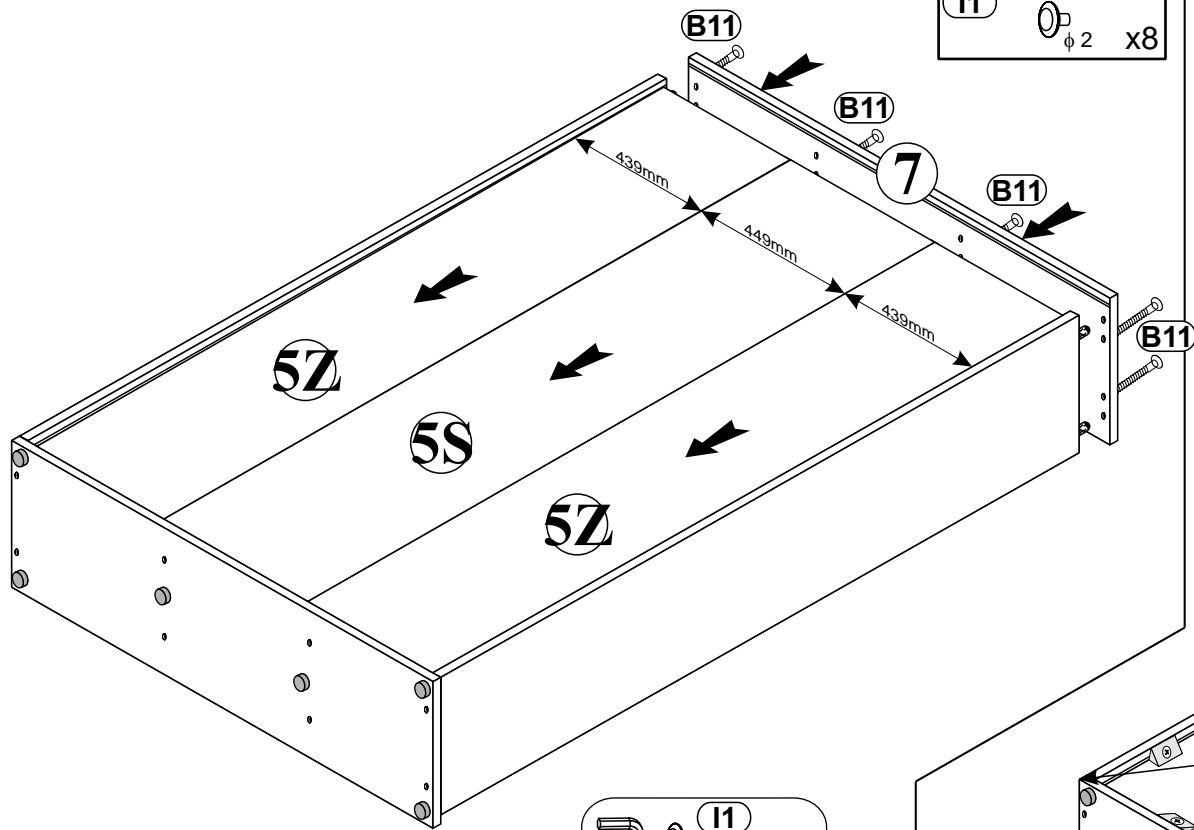
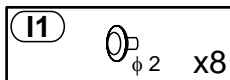
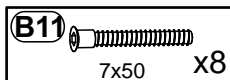

8

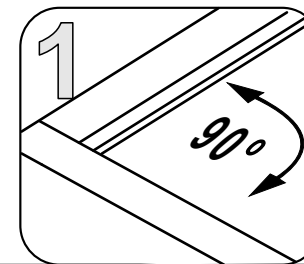
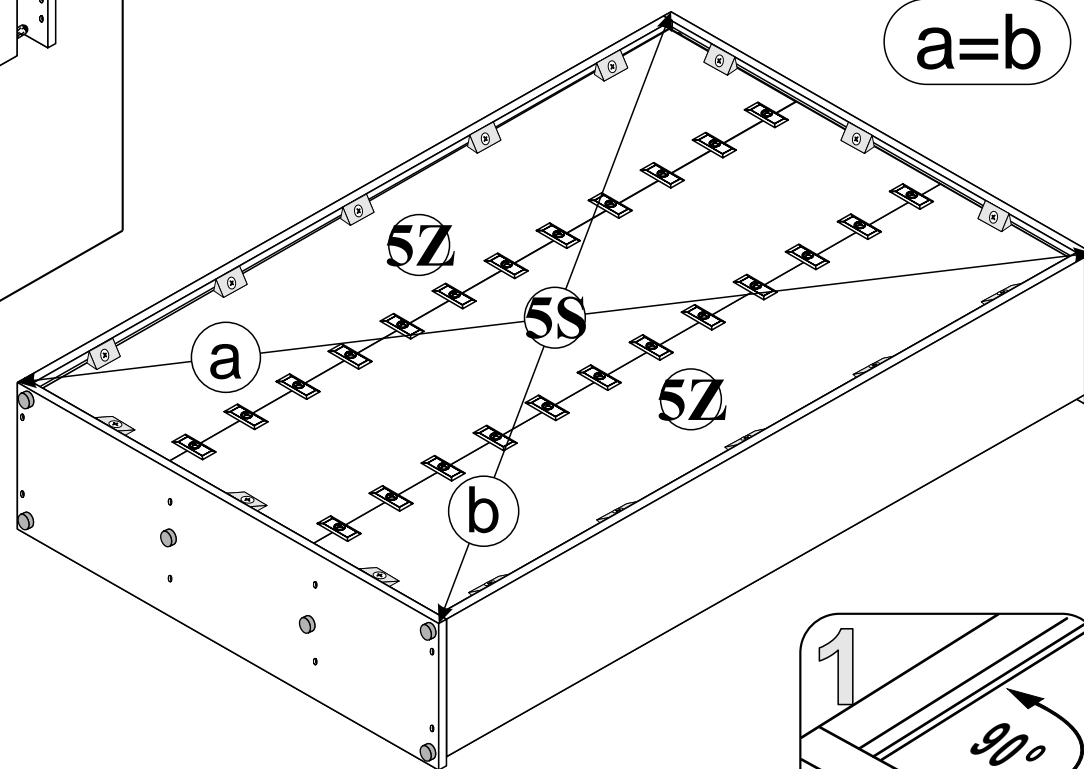
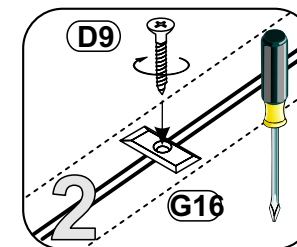
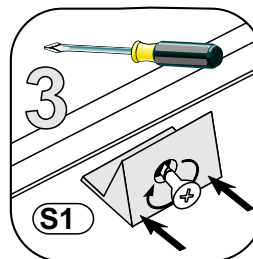
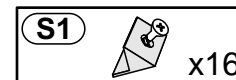
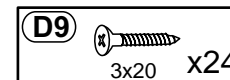

9

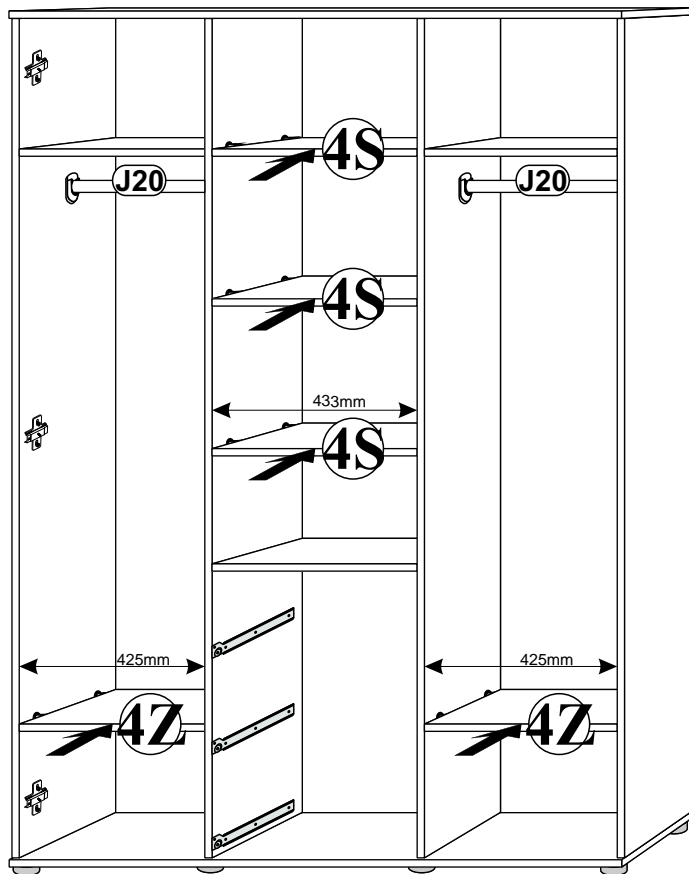
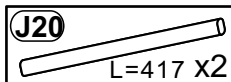
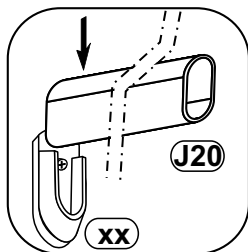

10

