

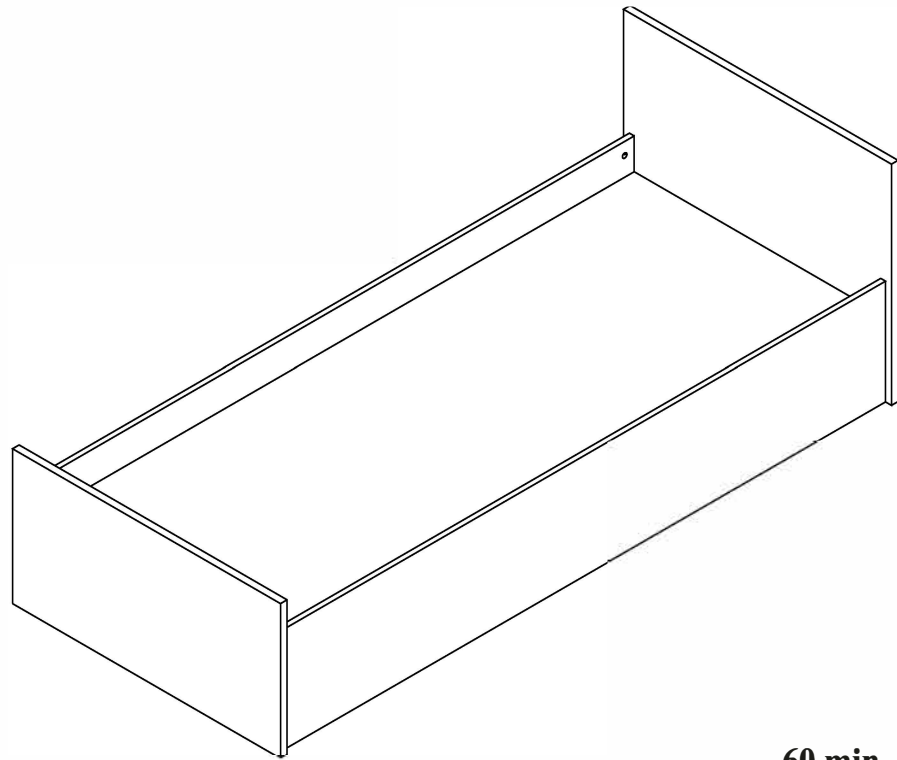

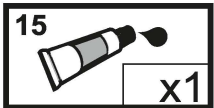

# M28

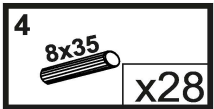
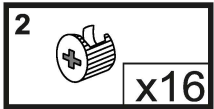
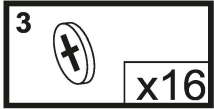
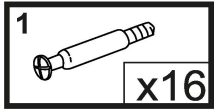
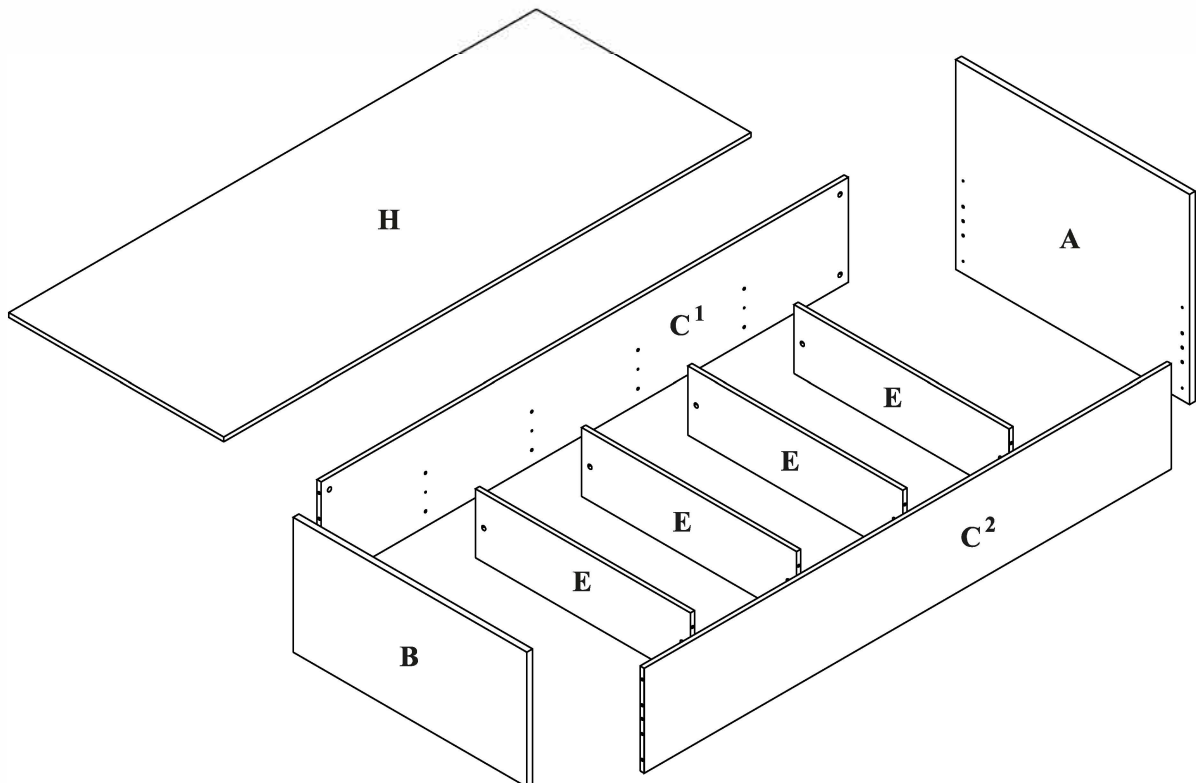
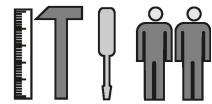

60 min.



1		x8
4	8x35 	x12
15		x1

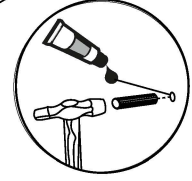
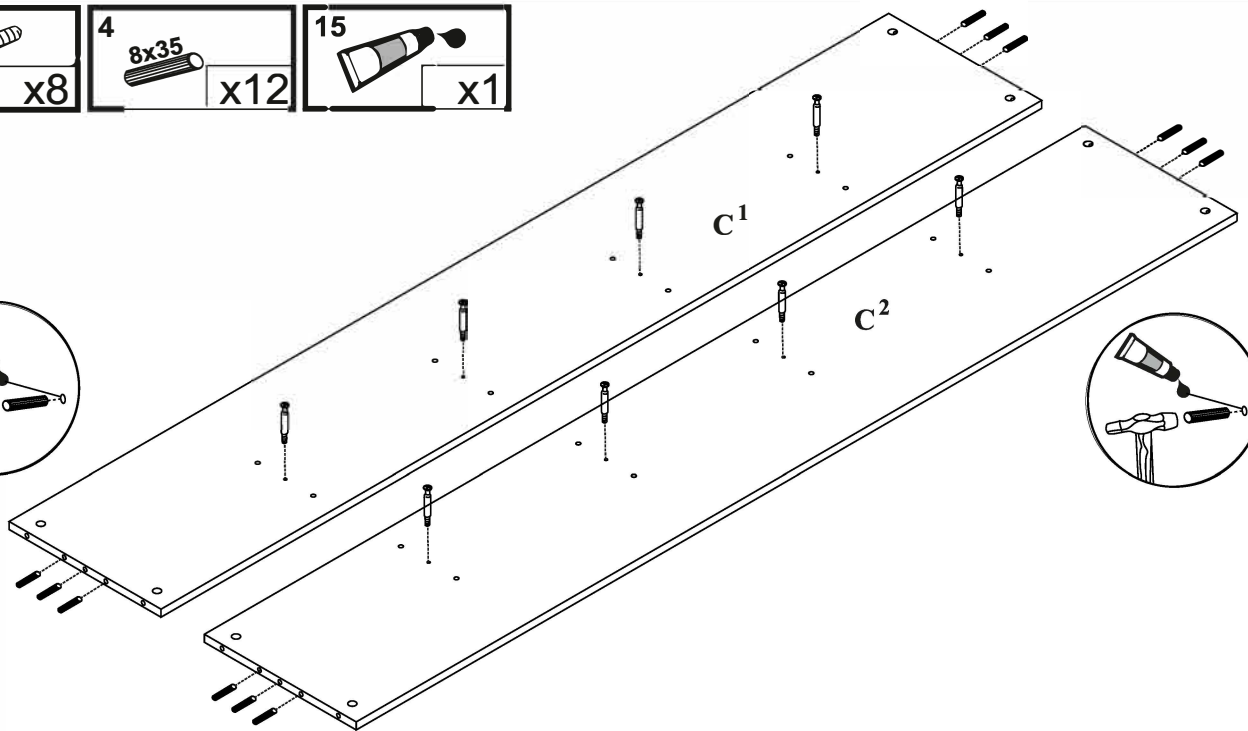
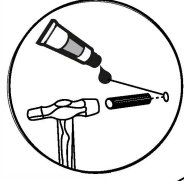



**1**

**2**

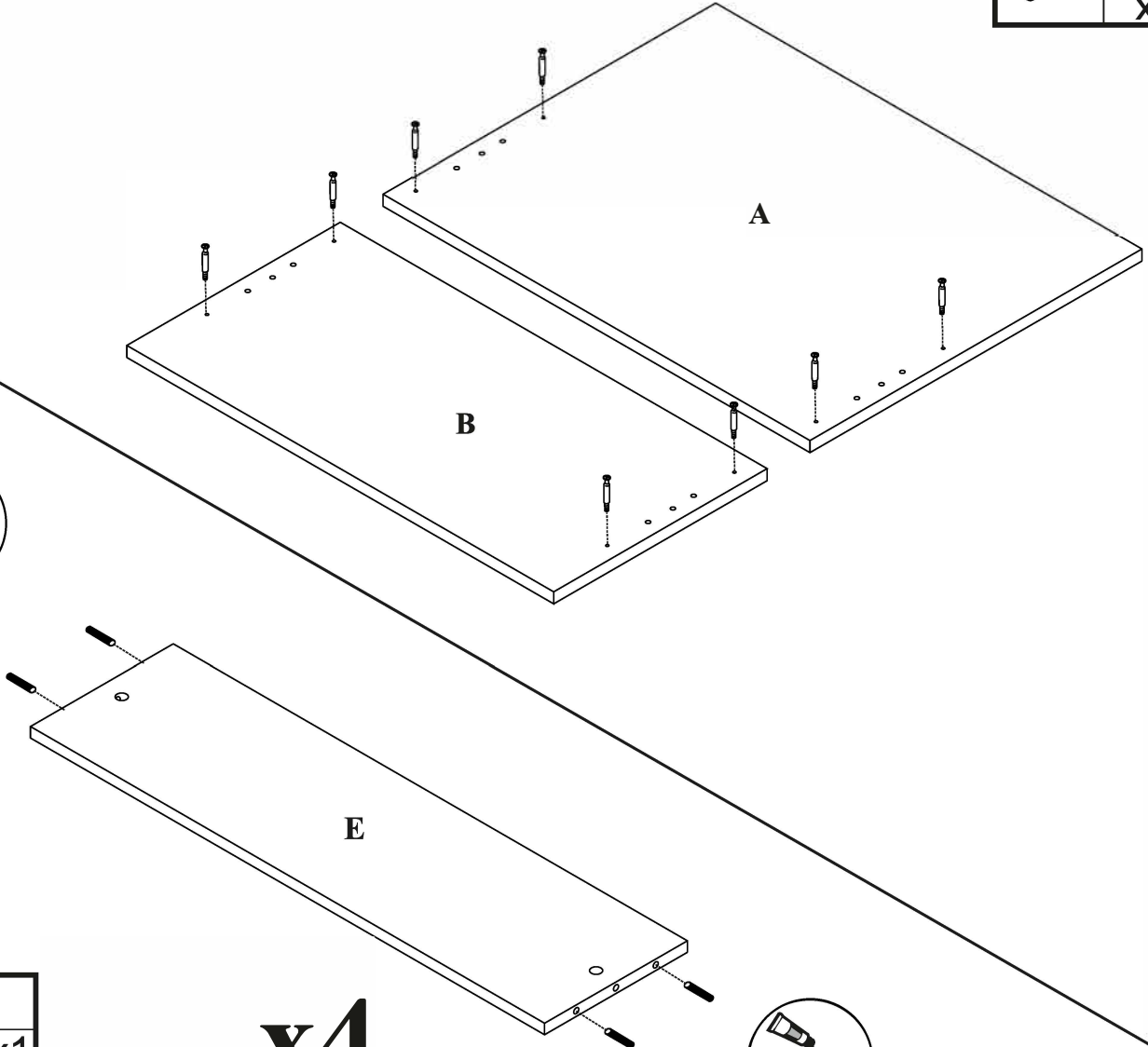
1		x8
---	---	----



**3**

15		x1
4	8x35 	x16

**x4**

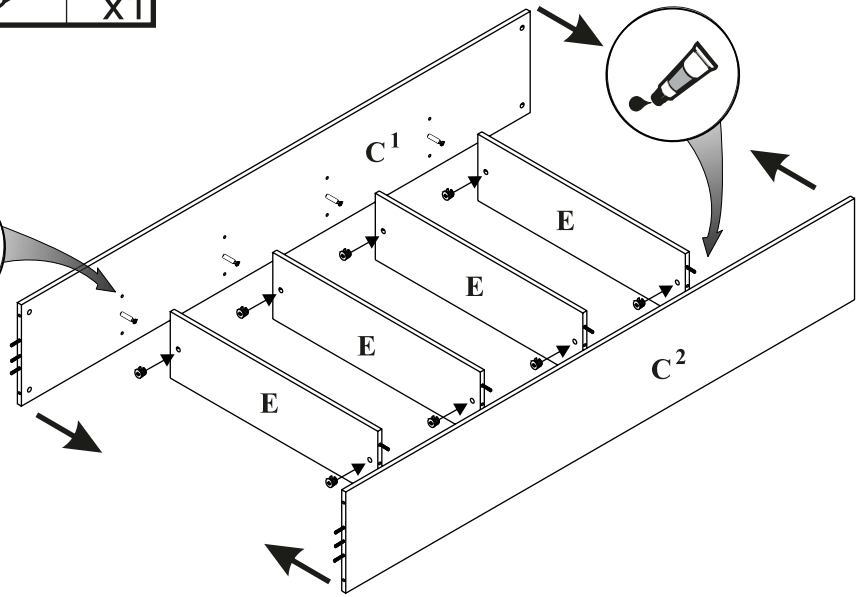
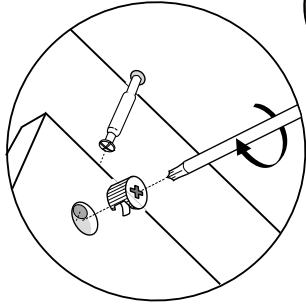
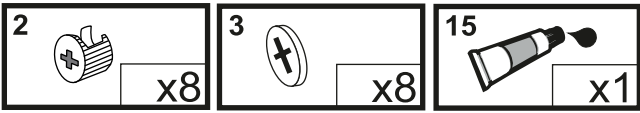

4

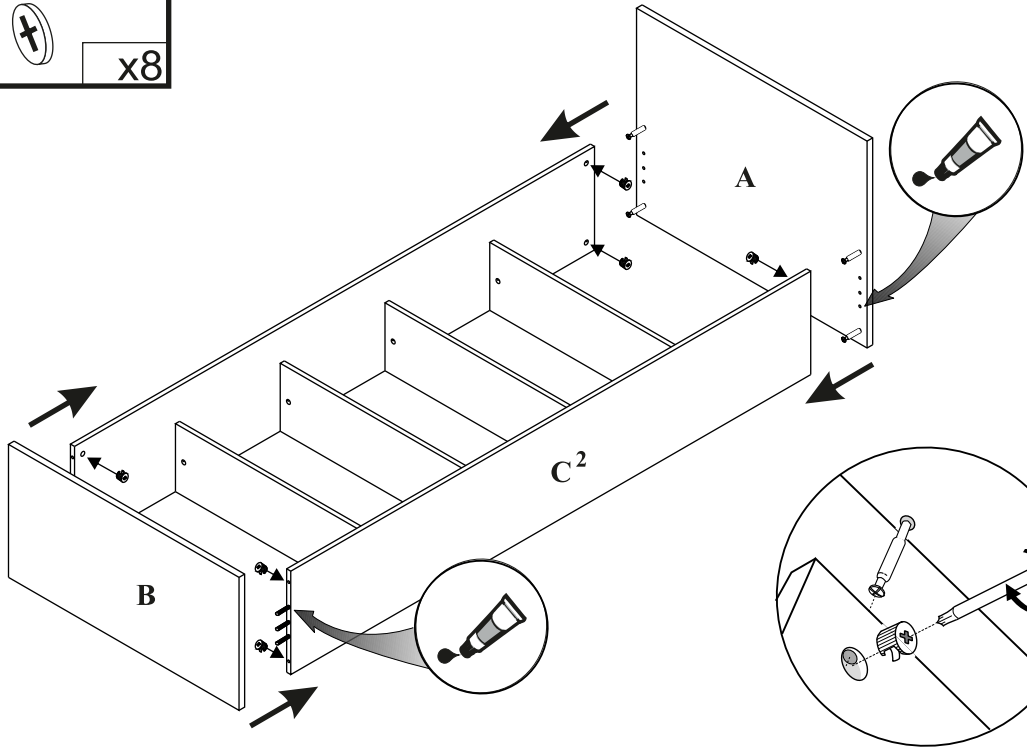
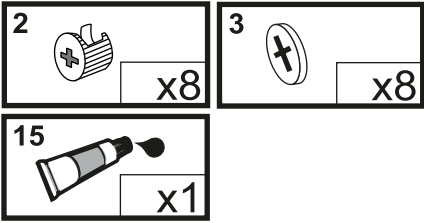

5

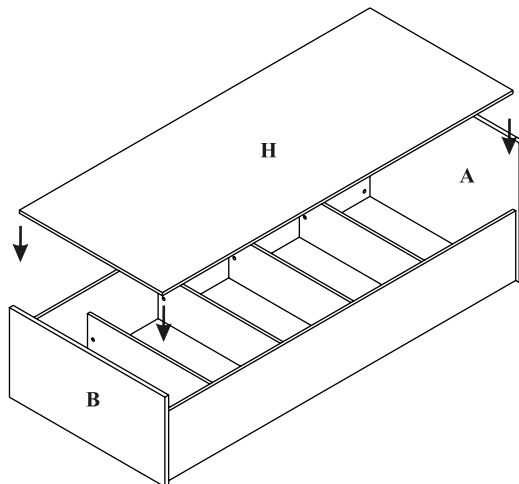

6