

OPTIMAL 21

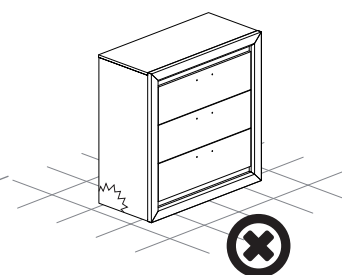

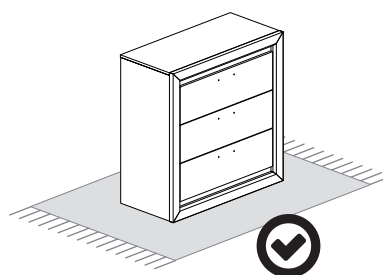

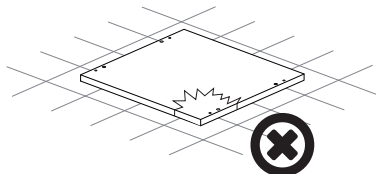
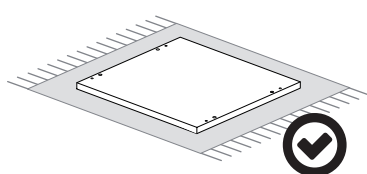
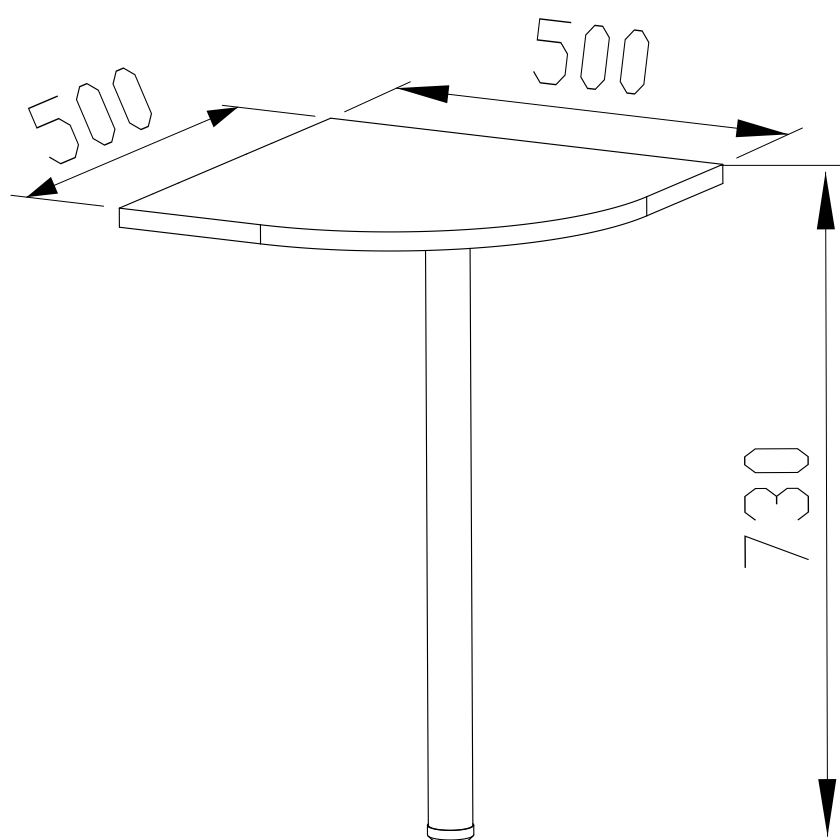
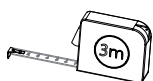
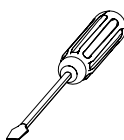
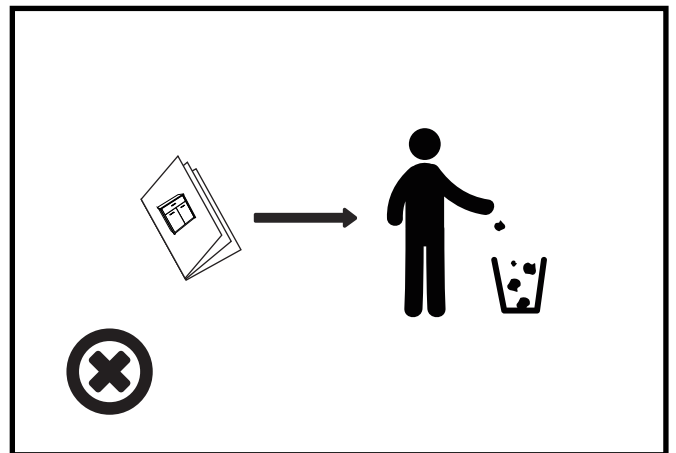
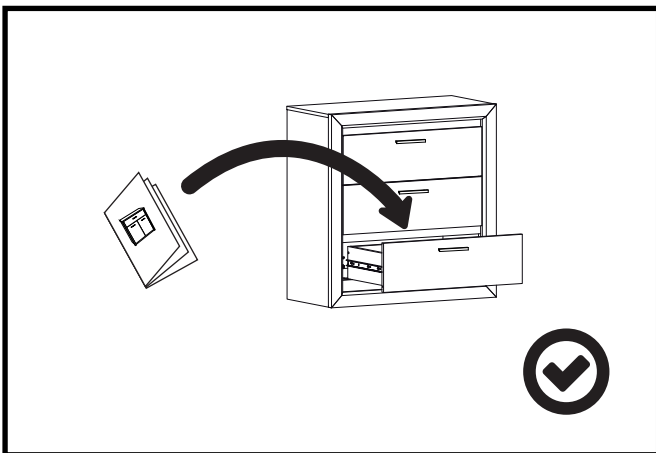
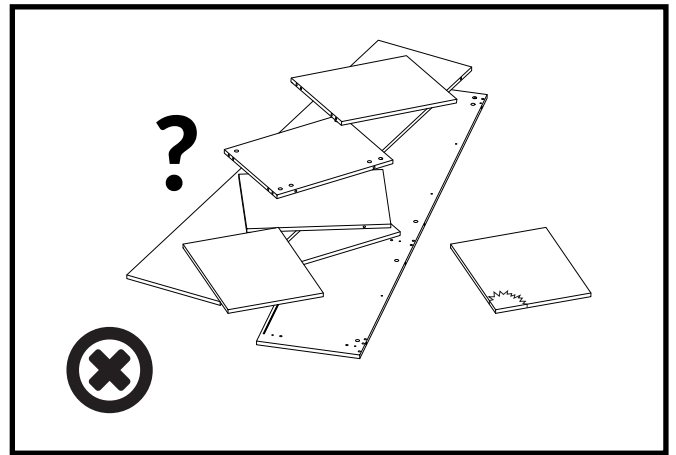
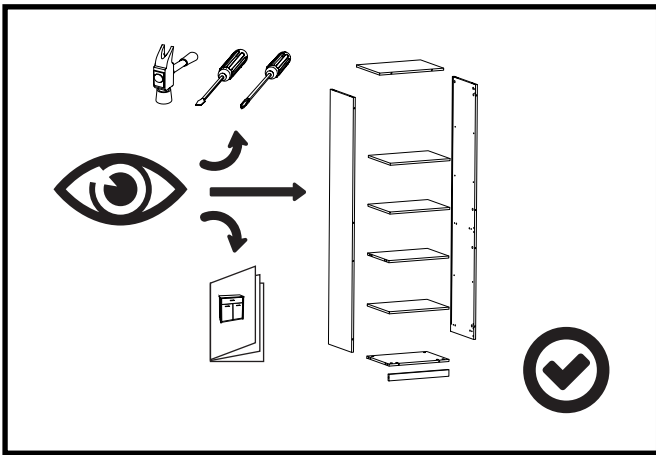
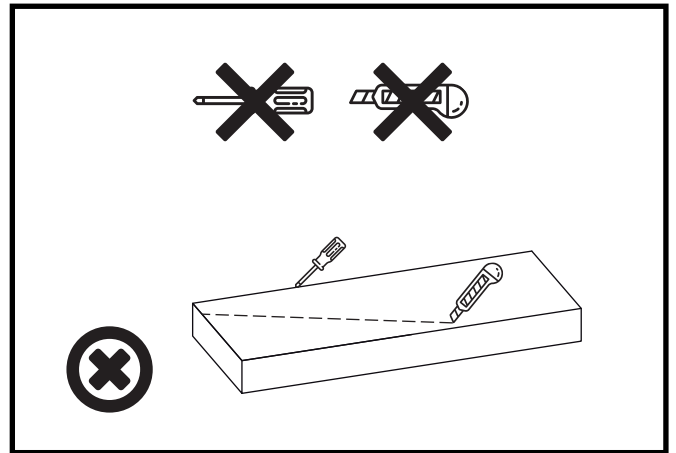
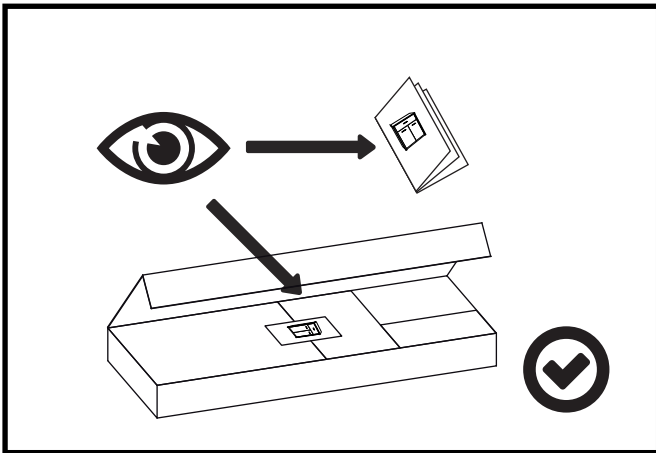
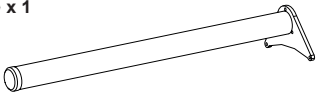
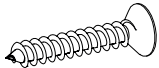
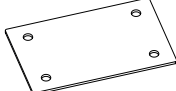
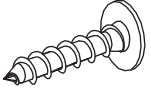

OPTIMAL 21

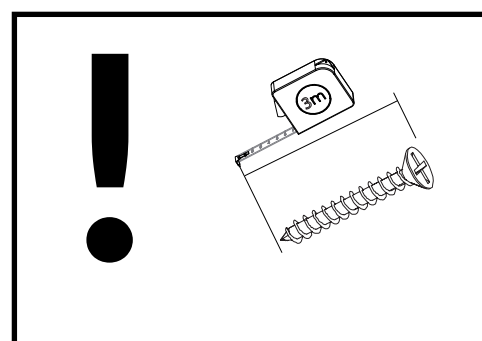
<p>NS1 x 1</p> 	<p>WT34 x 10</p> 	<p>PM1 x 4</p> 
<p>WT2 x 16</p> 		

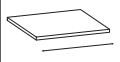
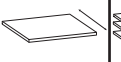

OPTIMAL 21

		
500	500	1

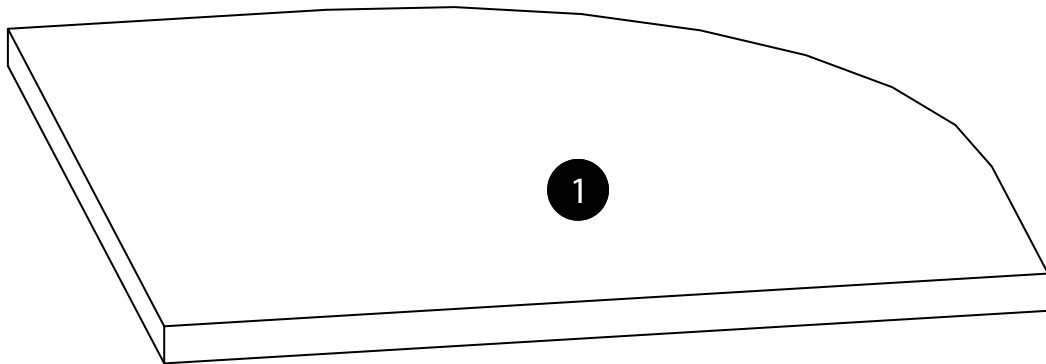

A ▶

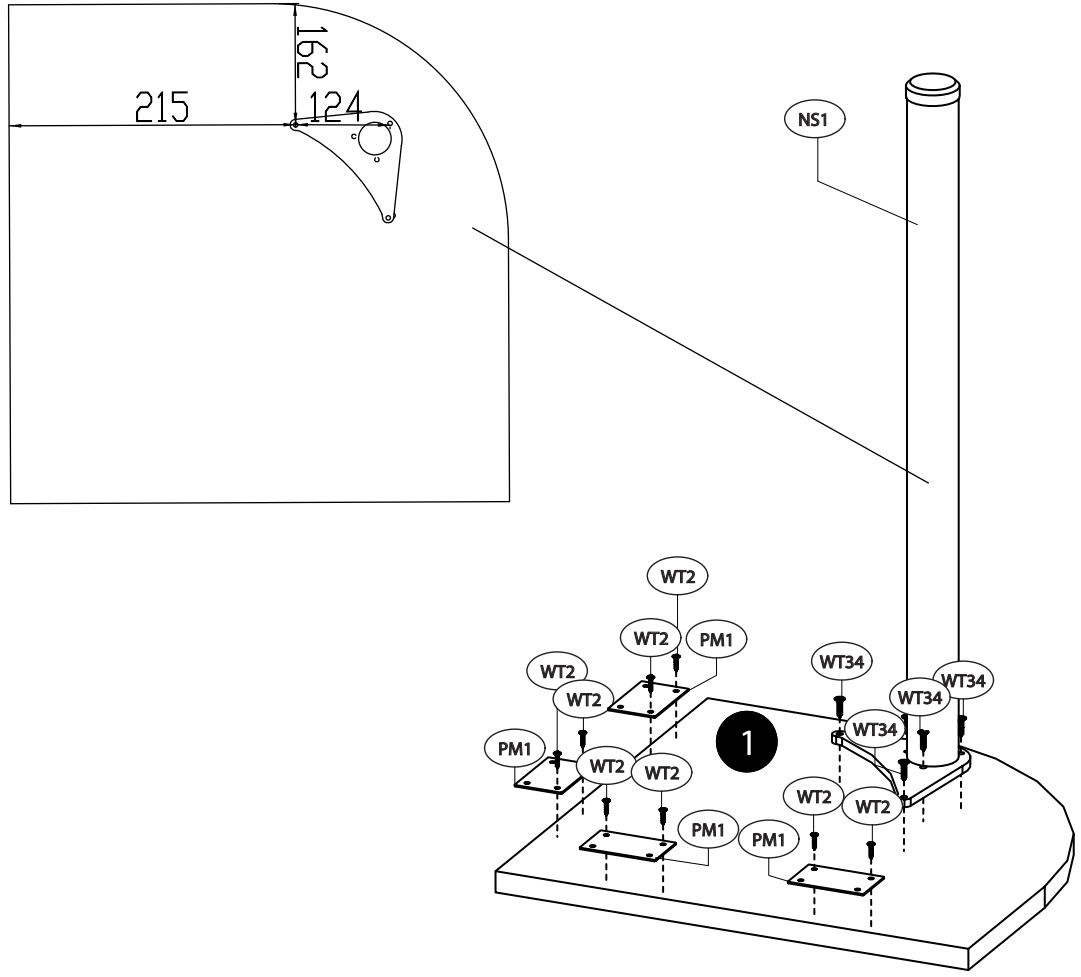

B ▶

