

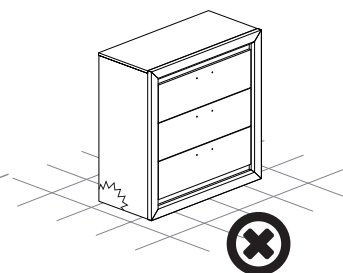

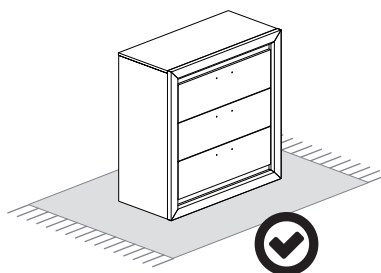

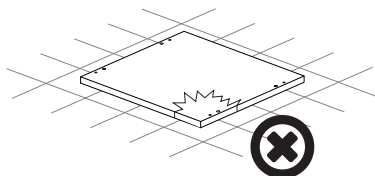

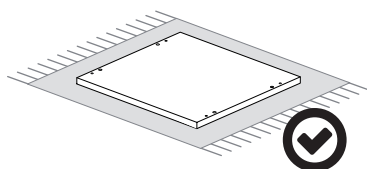

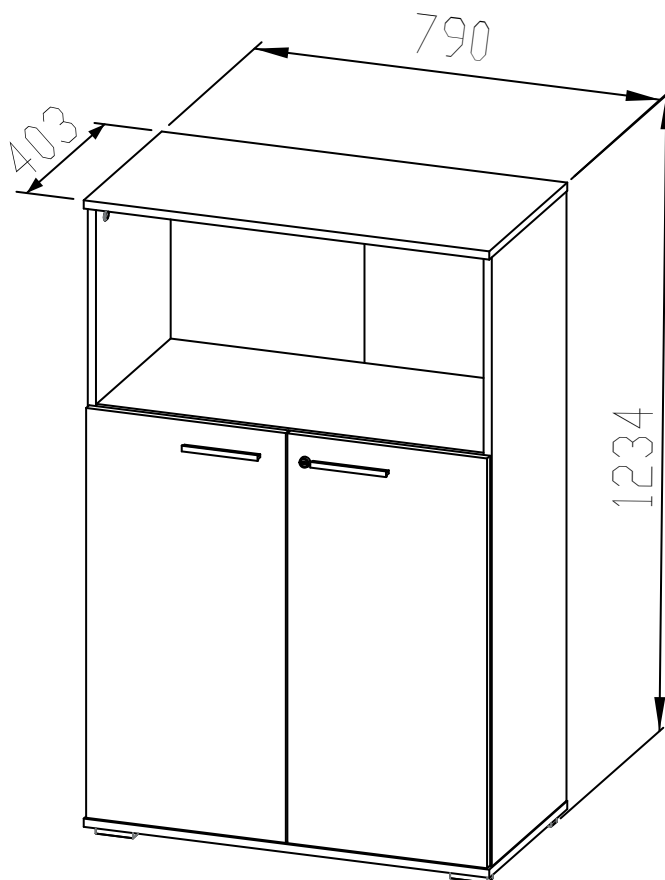
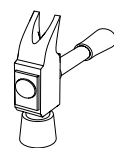
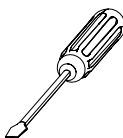
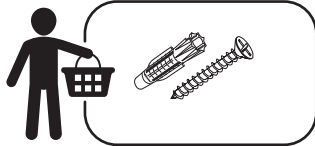
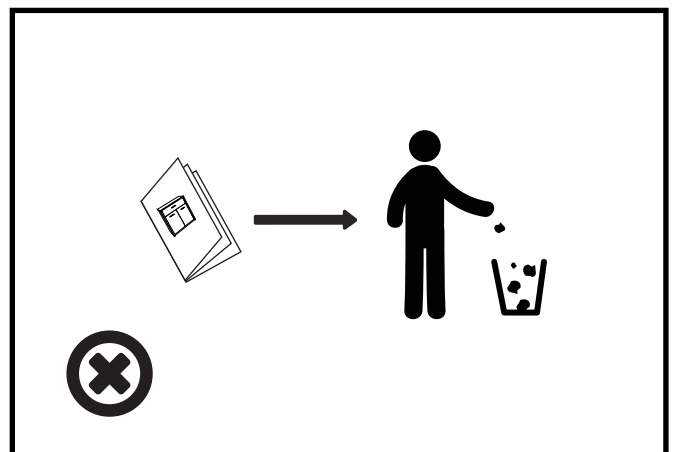
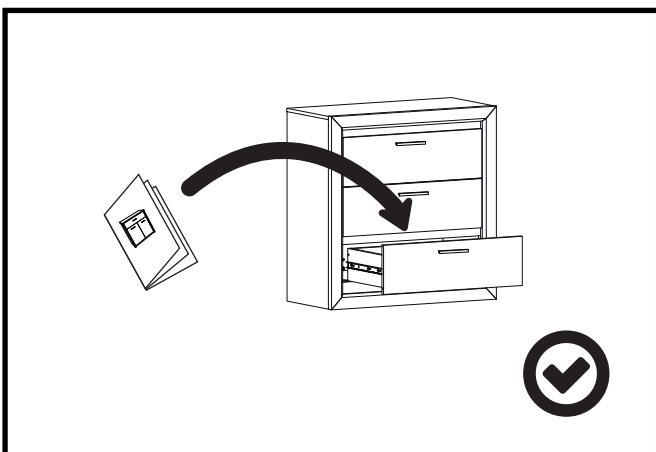
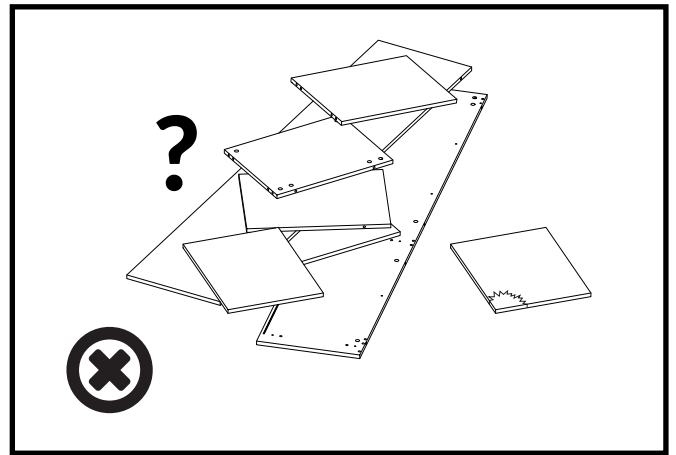
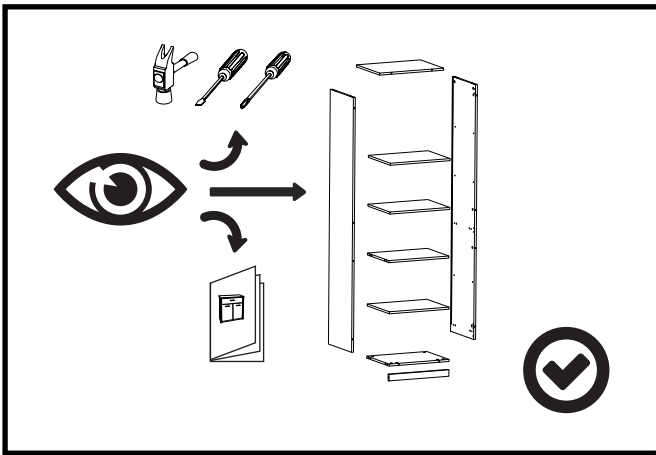
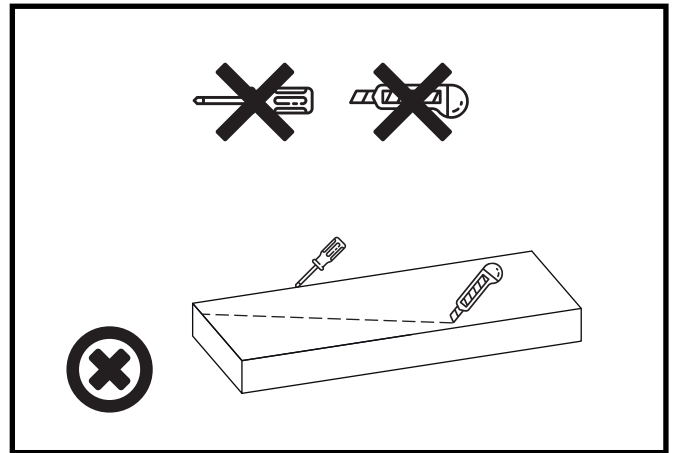
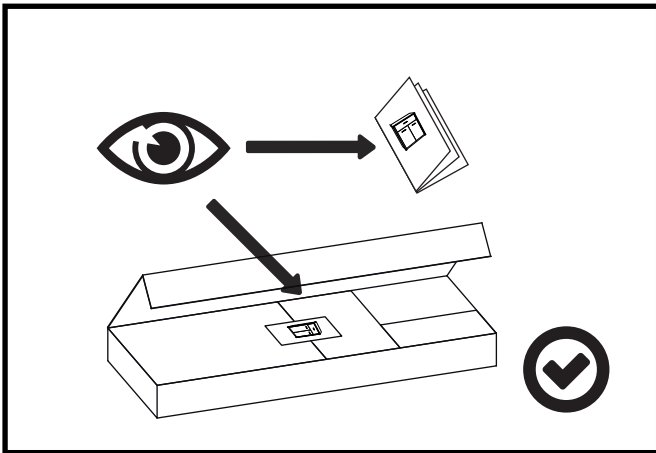
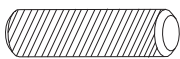
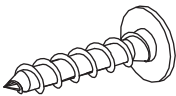

OPTIMAL 10



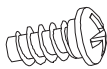
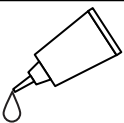

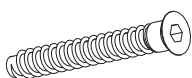
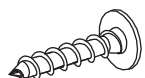
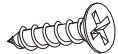

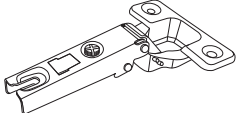
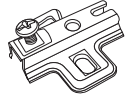
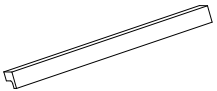
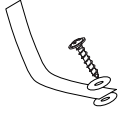
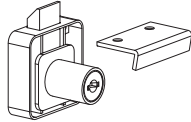
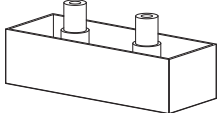
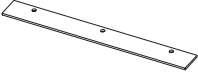
OPTIMAL 10

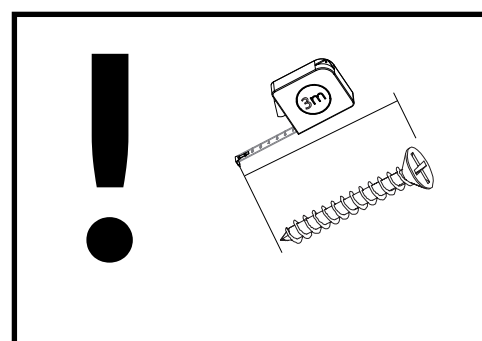
<p>K1 x 12</p> 	<p>WT31 x 4 4x25</p> 	<p>B2 x 8</p> 
<p>ZS2 x 8</p> 	<p>WT1 x 8 3,5x15</p> 	<p>x 1</p> 
<p>ZJ1 x 8</p> 	<p>WE2 x 8 6,3x13B</p> 	<p>KL x 1</p> 
<p>PO2 x 4</p> 	<p>KT1 x 4 6,3x50</p> 	<p>WT9 x 5 3x16</p> 
<p>WT4 x 4 3,5x20</p> 	<p>GW1 x 48</p> 	<p>ZP5 x 4</p> 
<p>PK1 x 4</p> 	<p>UO x 2</p> 	<p>PZK x 1</p> 
<p>ZK x 1</p> 	<p>ST2 x 4</p> 	<p>LD x 1</p> 

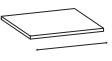
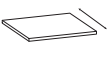

OPTIMAL 10

			
①	1182	386	1
②	1182	386	1
③	790	403	1
④	790	403	1
⑤	755	385	1
⑥	755	385	1
⑦	392	1208	2
⑧	794	389	1
⑨	794	389	1

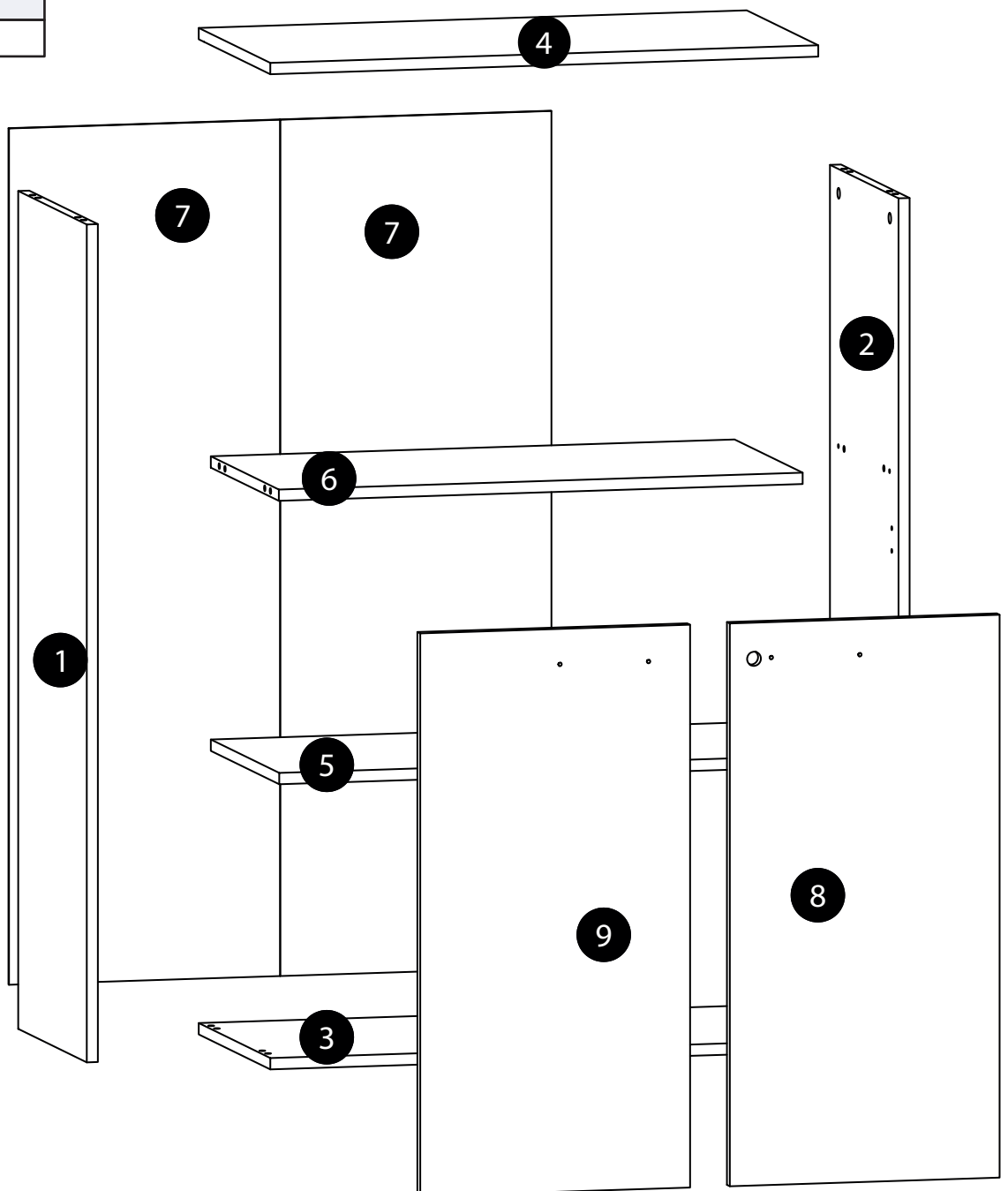

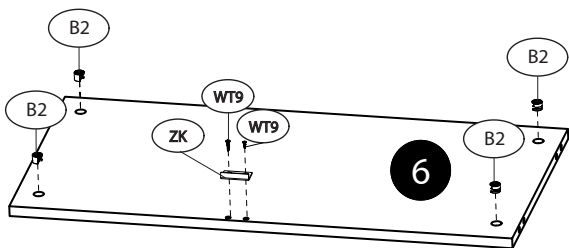
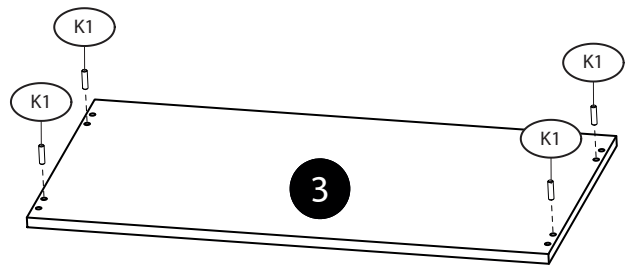
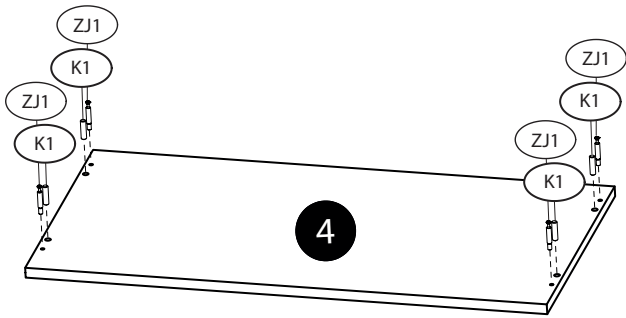
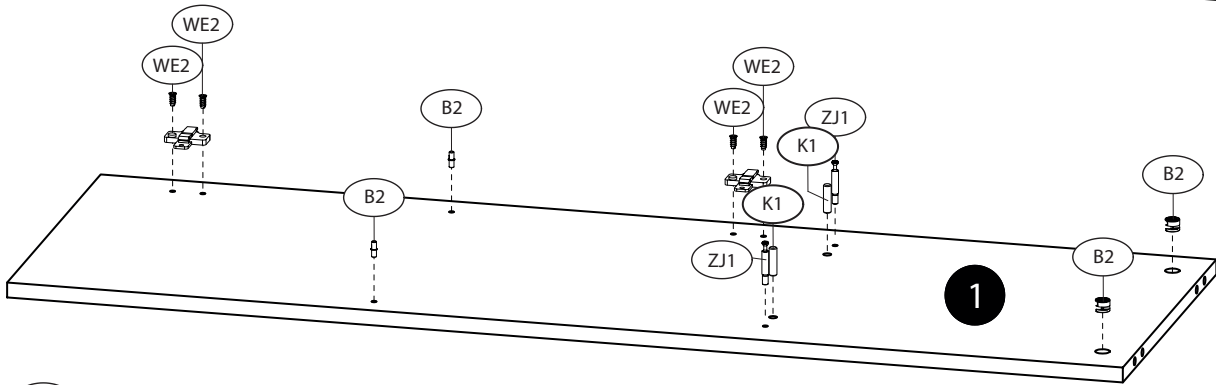
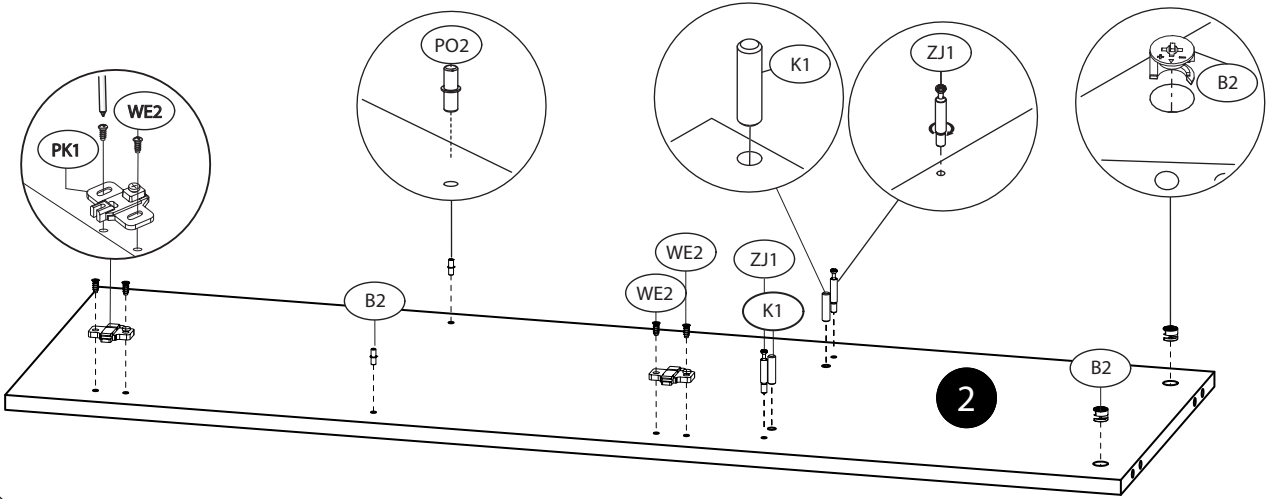
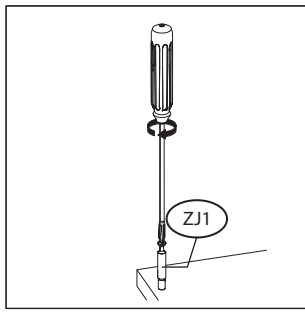
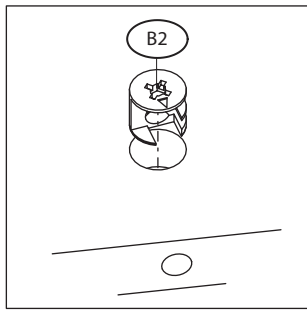
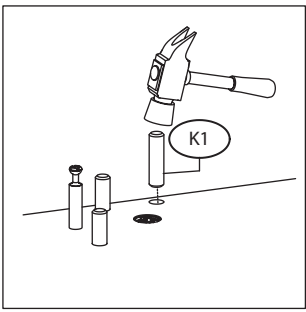

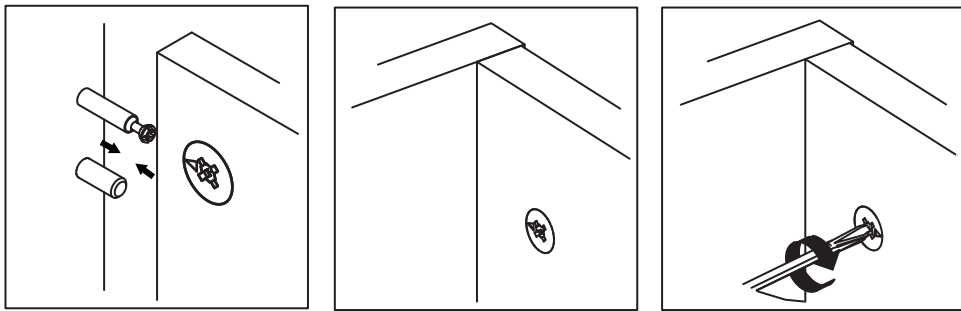
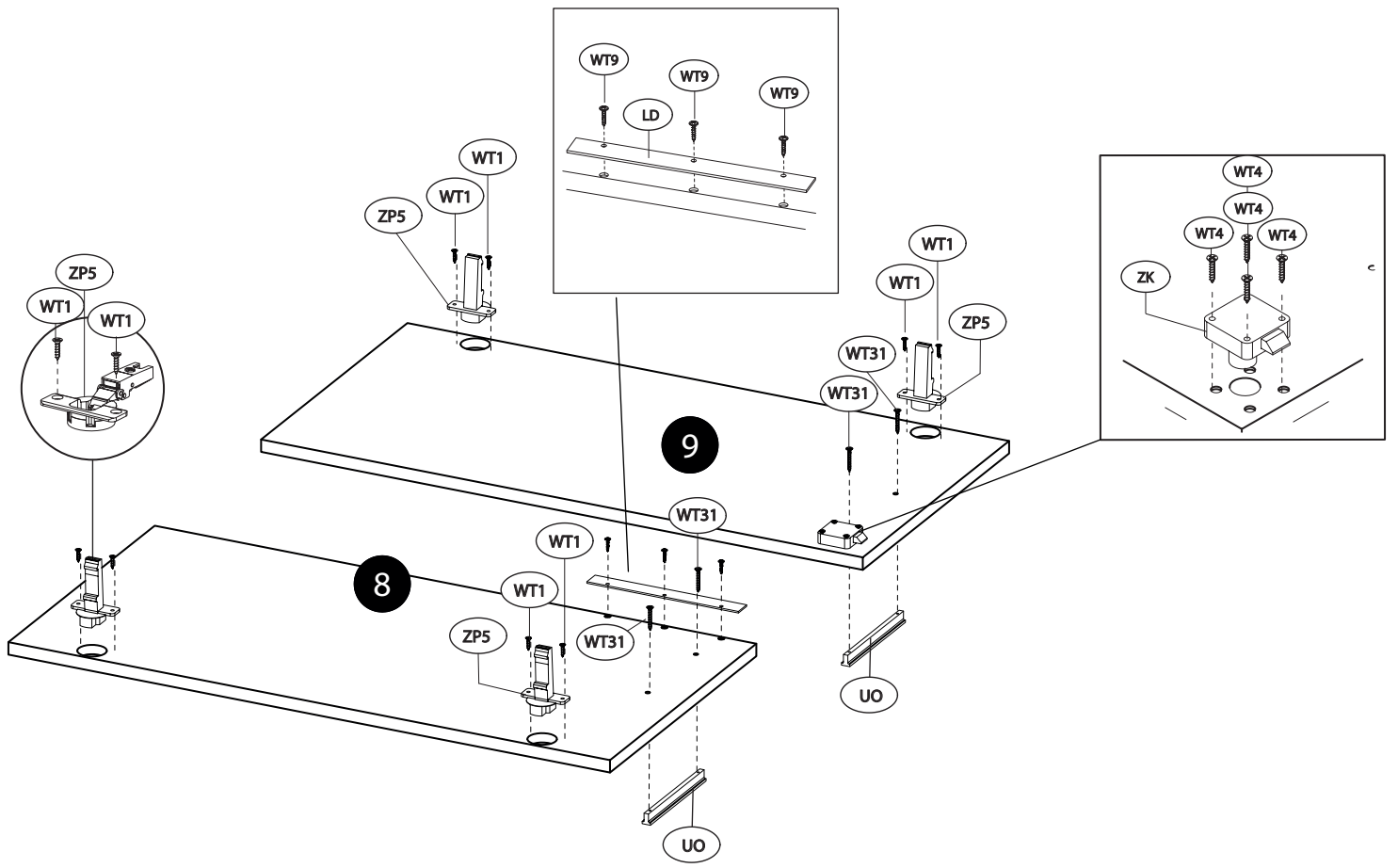

A ▶

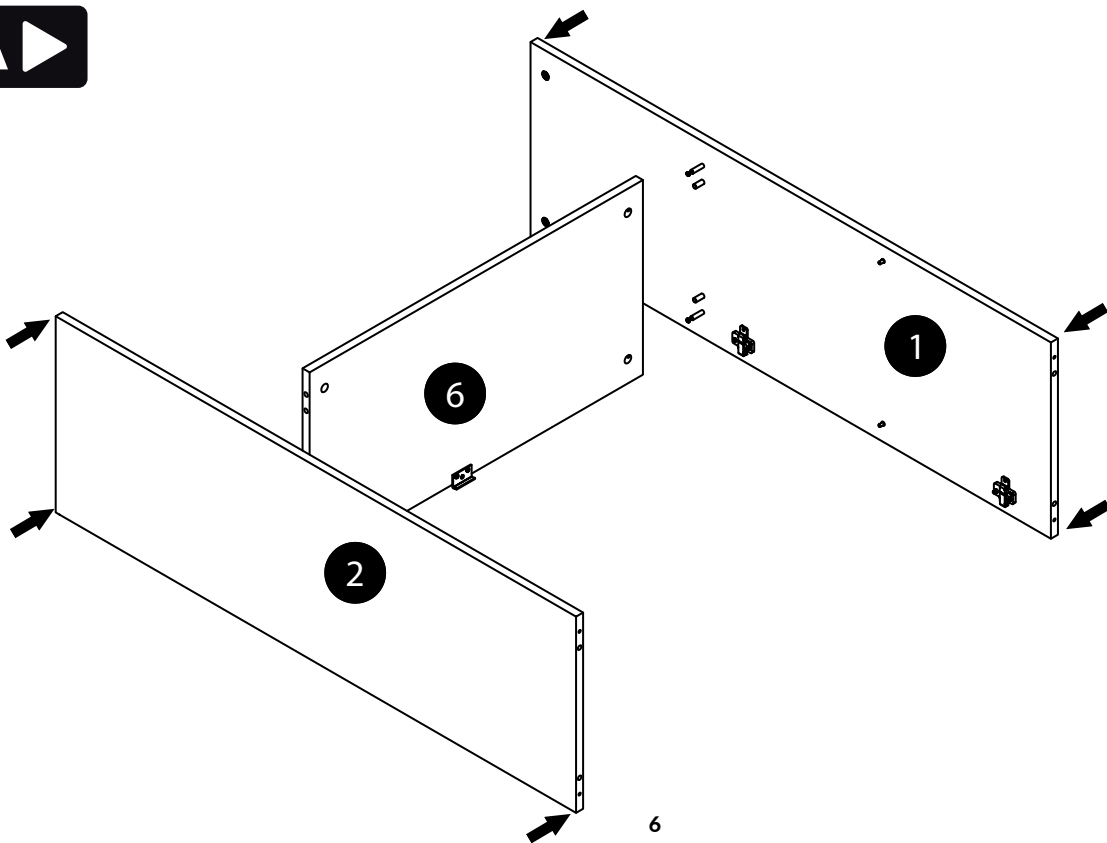

B ▶

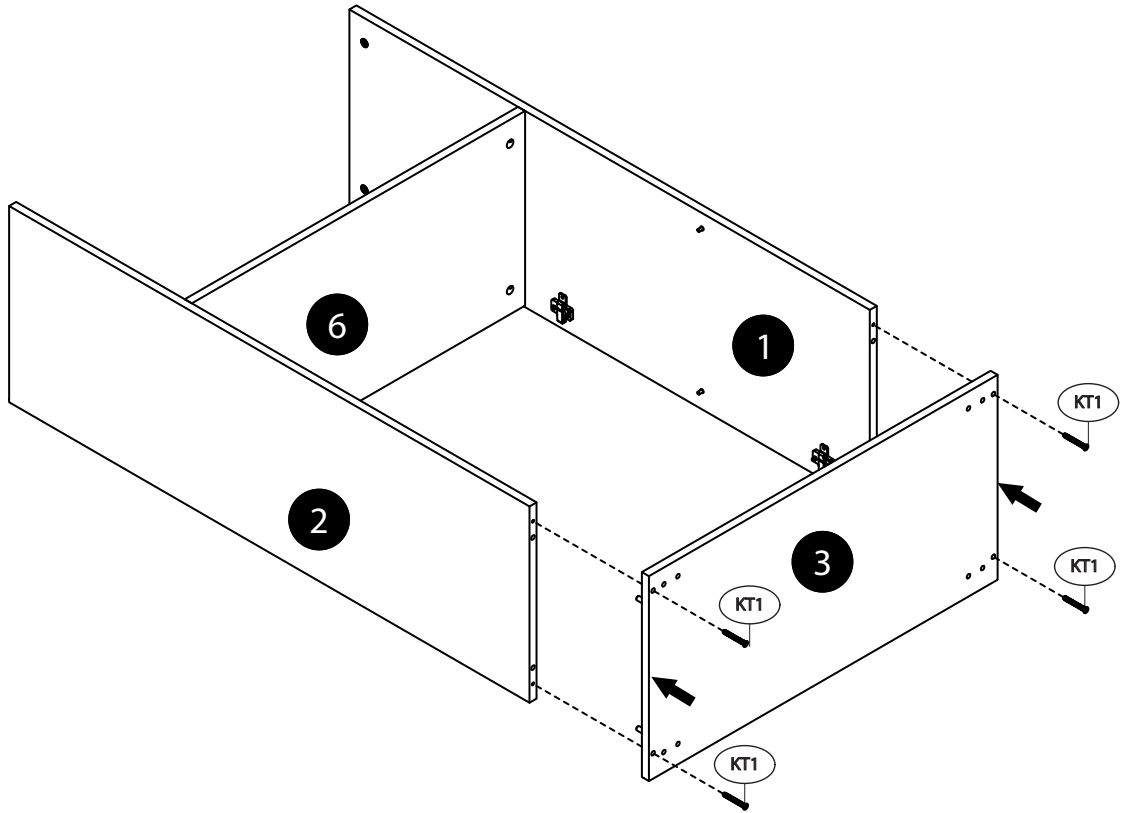

C ▶

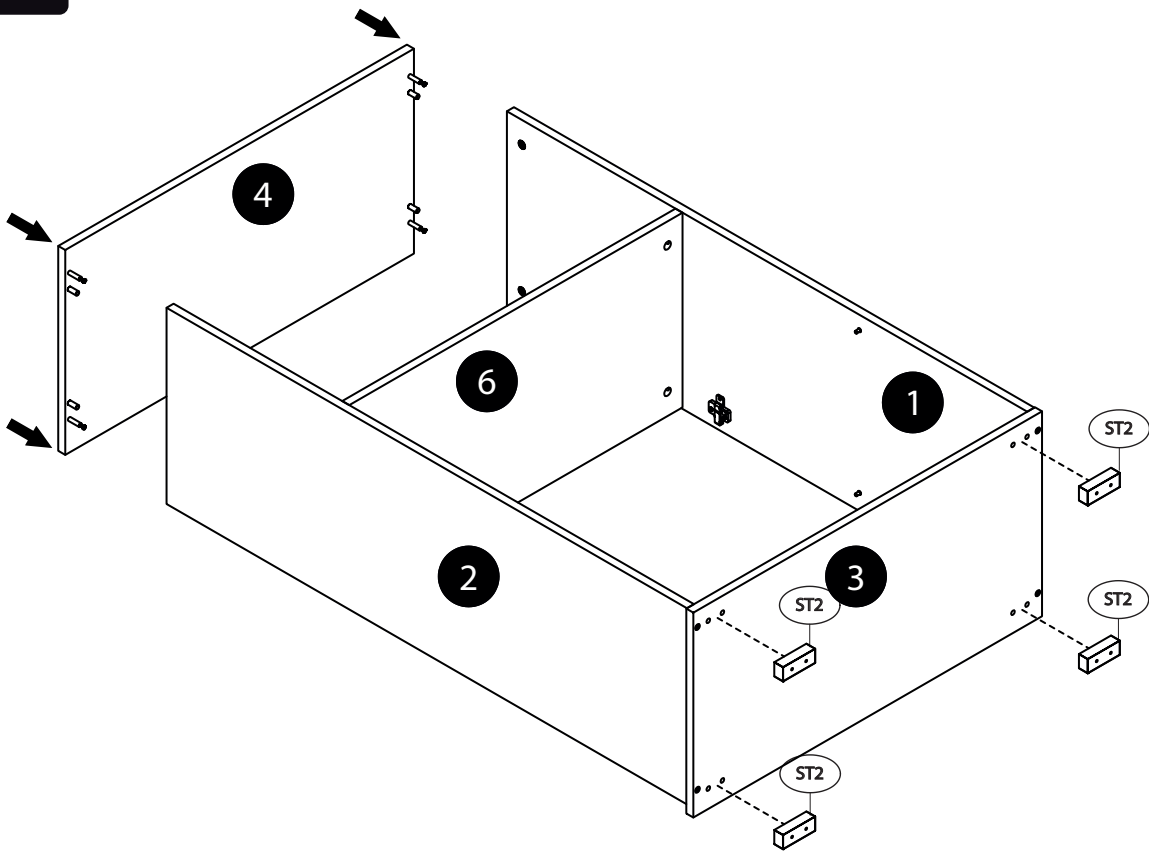

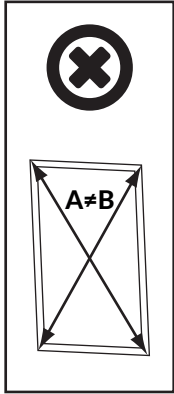
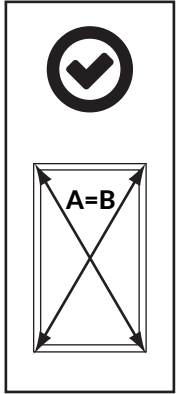
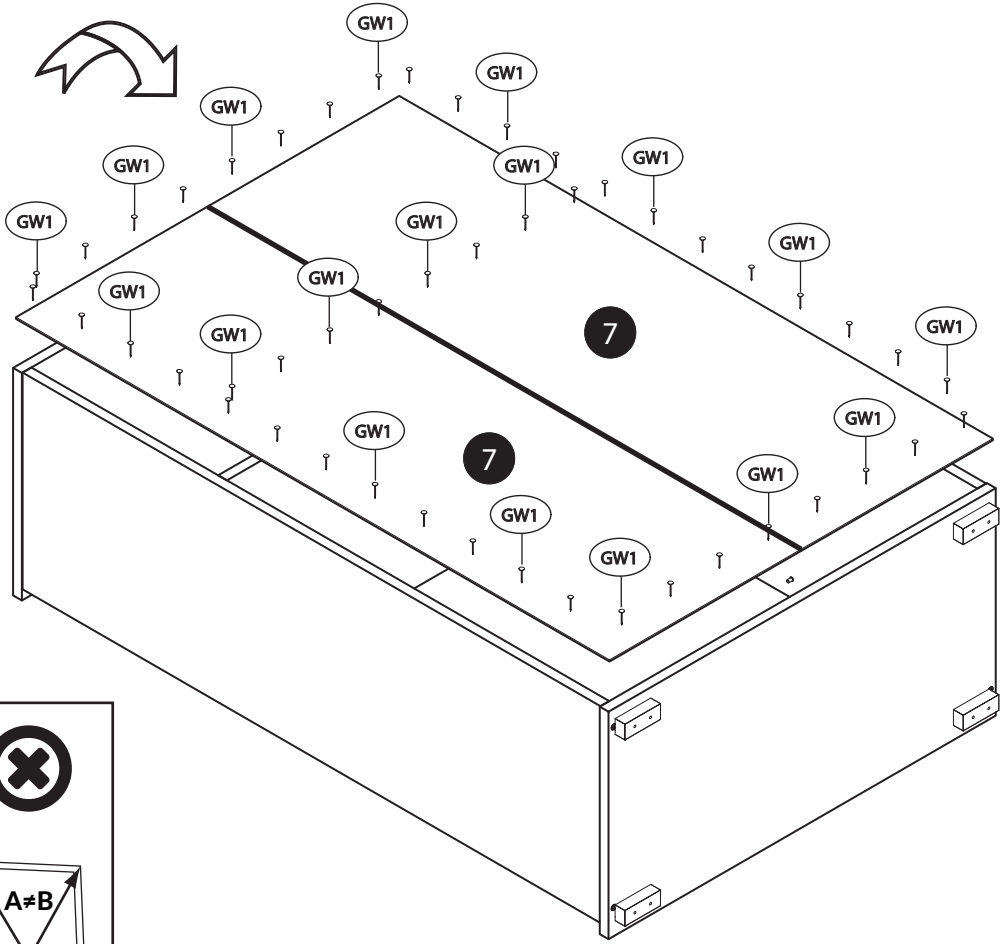

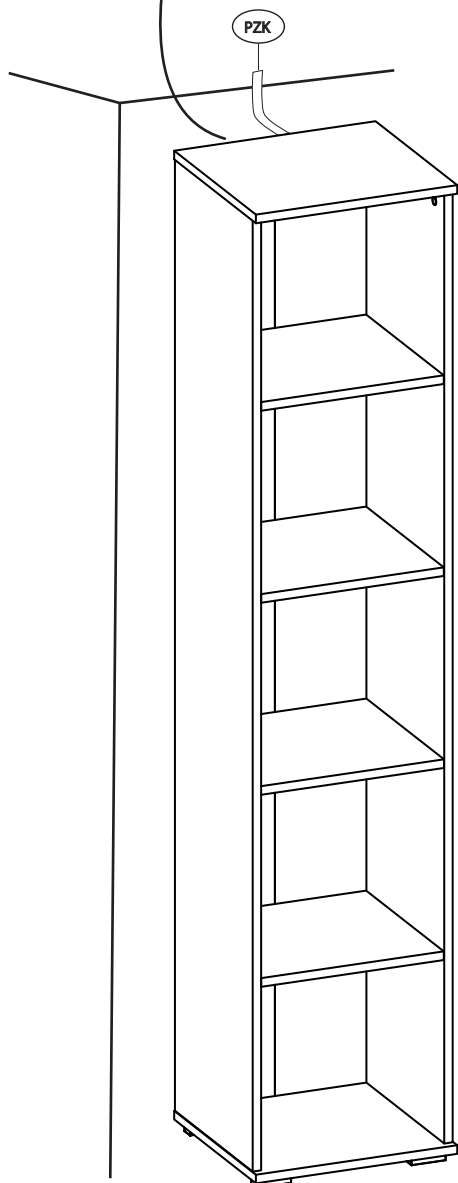
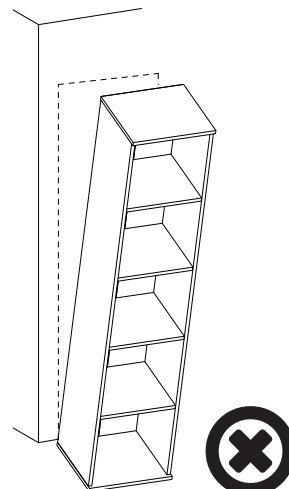
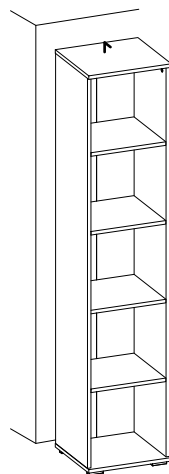
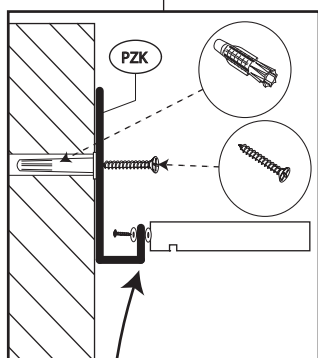
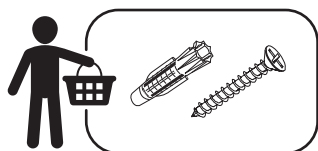

PL
UWAGA! Mebel należy trwale zamocować do ściany, aby uniknąć ryzyka związanego z przewróceniem się mebla. W paczce nie ma śrub mocujących, ponieważ rodzaj mocowania należy odpowiednio dobrać do rodzaju ściany. Dobierz właściwe do twojego rodzaju ściany.

CZ
POZOR! Nábytek je nutné pevně připevnit ke zdi, abychom se vyhnuli riziku spojenému s jeho převrnutím. Součástí balení nejsou připevňovací šrouby, protože způsoby připevnění je nutné zvolit podle druhu stěny. Vyberte správný pro Váš typ stěny.

SK
POZOR! Nábytok musí byť trvalo pripevnený k stene tak, aby sa zamedzilo riziku prevrátenia. Balík neobsahuje upevňovacie skrutky, pretože typ upevnenia je treba vybrať podľa typu steny. Vyberte typ vhodný pre Vašu stenu.

D
ACHTUNG! Um alle mit dem Umkippen des Möbels verbundenen Risiken auszuschließen, muss das Möbel fest an der Wand verankert werden. Beschläge für die Wandbefestigung sind nicht beige packt, da diese von der jeweiligen Wandbeschaffenheit abhängig sind. Bitte solche Befestigungschläge wählen, die für die heimischen Wände geeignet sind.

FR
ATTENTION! Ce meuble doit être fixé en permanence au mur pour éviter les risques de chute. Les vis de fixationne sont pas livrées car le type de fixation doit être choisi en fonction du type de mur. Sélectionnez les fixations adaptées au mur.

E
¡ATENCIÓN! El mueble debe ser fijado permanentemente a la pared para evitar el riesgo relacionado con el vuelco del mueble. En el paquete no hay tornillos de fijación, ya que se debe elegir el tipo de fijación adecuado para el tipo de pared. Elija el apropiado para su tipo de pared.

EN
WARNING! To prevent this furniture from tripping over, fix it to the wall permanently. Fixing devices are not included since different wall materials require different types of fixing devices. Please make sure you chose the correct ones for your type of wall.

I
ATTENZIONE! Il mobile deve essere permanentemente fissato alla parete per evitare i rischi derivanti da un ribaltamento del mobile. La confezione non include le viti di fissaggio, in quanto il tipo di fissaggio deve essere scelto in base al tipo di parete. Utilizzare viti appropriate in base al materiale della parete.

SLO
POZOR! Pohištvo trajno pritrdite na steno, da preprečite tveganje, da se prevrne. V paketu ni pritrdilnih vijakov, saj je treba način pritrditve ustrezno izbrati glede na vrsto stene. Izberite način, ki je ustrezen za vašo steno.

HR
NAPOMENA! Namještaj mora biti trajno pričvršćen za zid, kako bi se izbjegao rizik od njegova prevrtanja. U paketu nema vijaka za pričvršćivanje, jer se vrsta montaže mora prilagoditi vrsti zida. Odaberite pravu vrstu prema Vašoj vrsti zida.

HU
FIGYELEM! Rögzítse a bútorokat a falhoz, hogy elkerülje a bútor felborulásának kockázatát. A készletben nem találhatóak rögzítőcsavarok, mivel a rögzítés típusa a fal típusától függ. Válassza ki a fal típusának megfelelő kötőelemeket.

RU
ПРИМЕЧАНИЕ! Эту мебель необходимо всегда прикреплять к стене, чтобы избежать рисков, связанных с переворотом мебели. В пакете нет крепежных винтов, потому что тип крепления должен быть выбран в соответствии с типом стены. Выберите, пожалуйста, правильные винты к вашей стене.

