

A	B	C (mm)		D
1	S220-1029	1882	540	2/3
2	S220-1030	1882	540	2/3
3	S220-2021	966	540	1/3
4	S220-2022	966	540	1/3
5	S220-3014	933	520	1/3
6	S220-7023	1934	496	3/3
7	S220-7024	1934	496	3/3
8	S220-9306	1892	943	2/3
9	dr-926	926	30	1/3
10	S220-5511	300	179	1/3
11	S220-7032	100	236	3/3

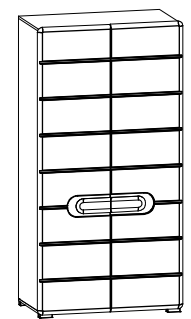

- 8x a108
- 8x b51
- 6x e1
- 12x f1
- 1x k53
- 4x k77
- 10x l1
- 22x l2
- 2x n1
- 16x o54
- 2x p1
- 9x p36
- 17x p38
- 16x p51
- 6x r1
- 6x r3
- 12x r42
- 12x s2
- 1x z1

- 2x n26\1
- 1x p38

1

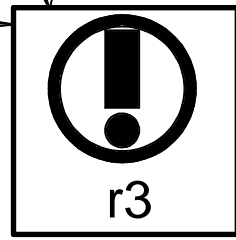
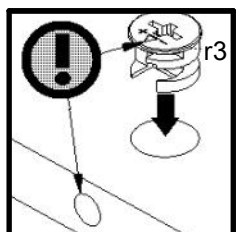
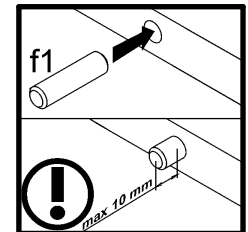
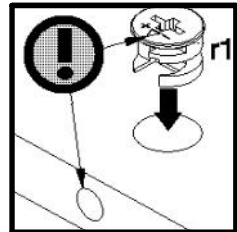
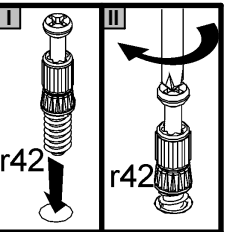
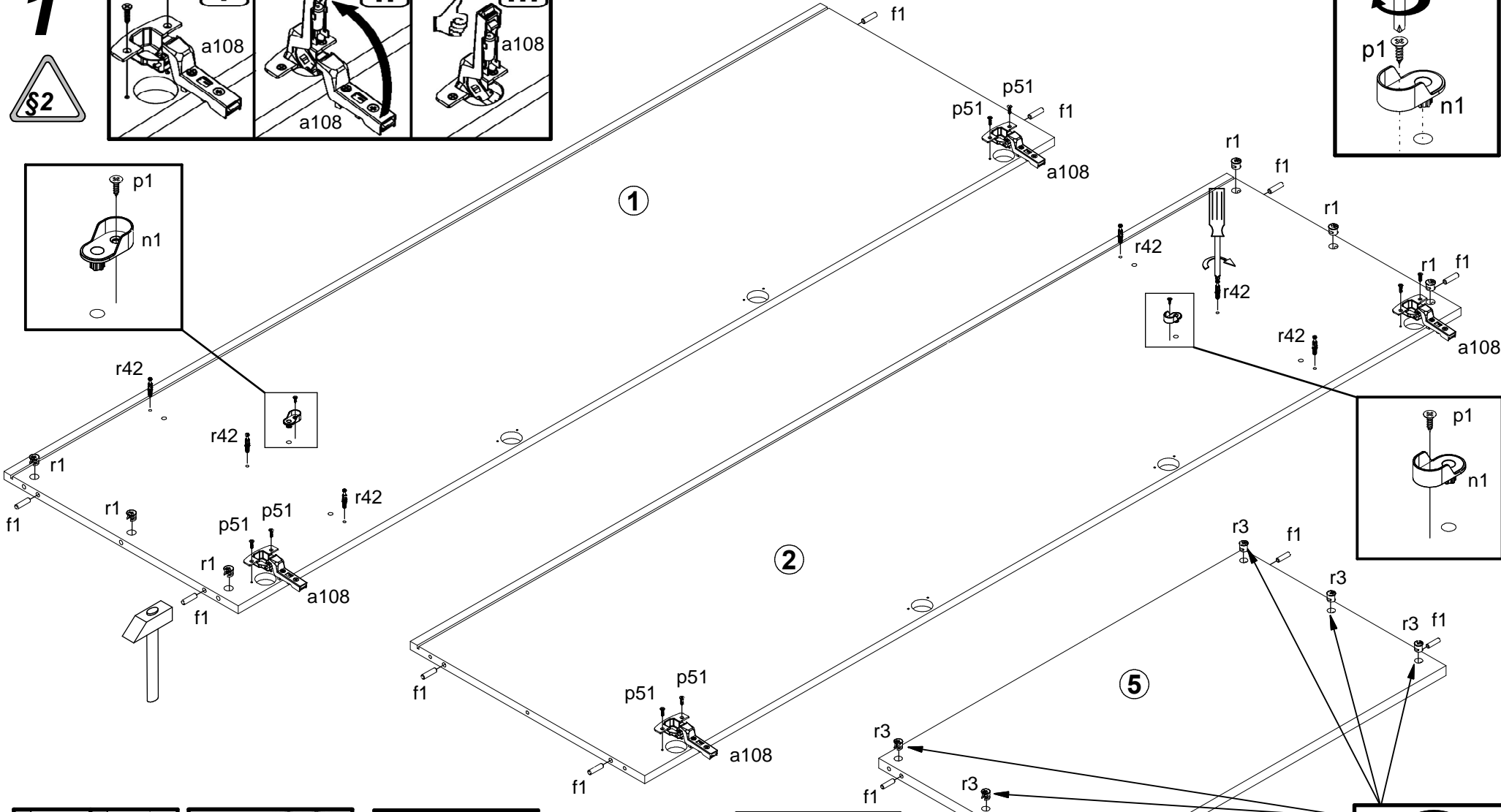
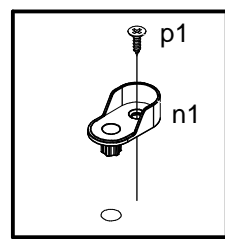
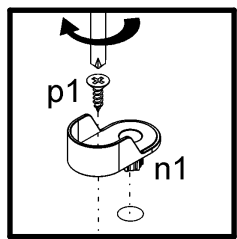
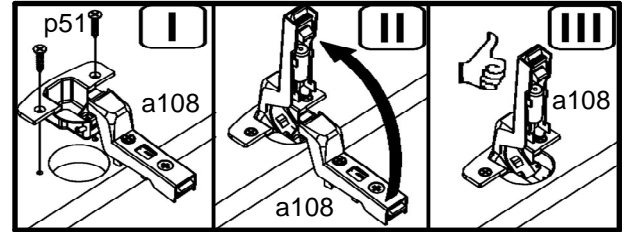

1

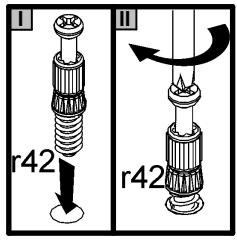
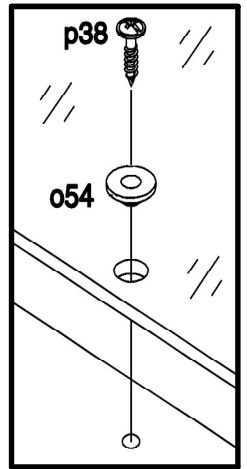
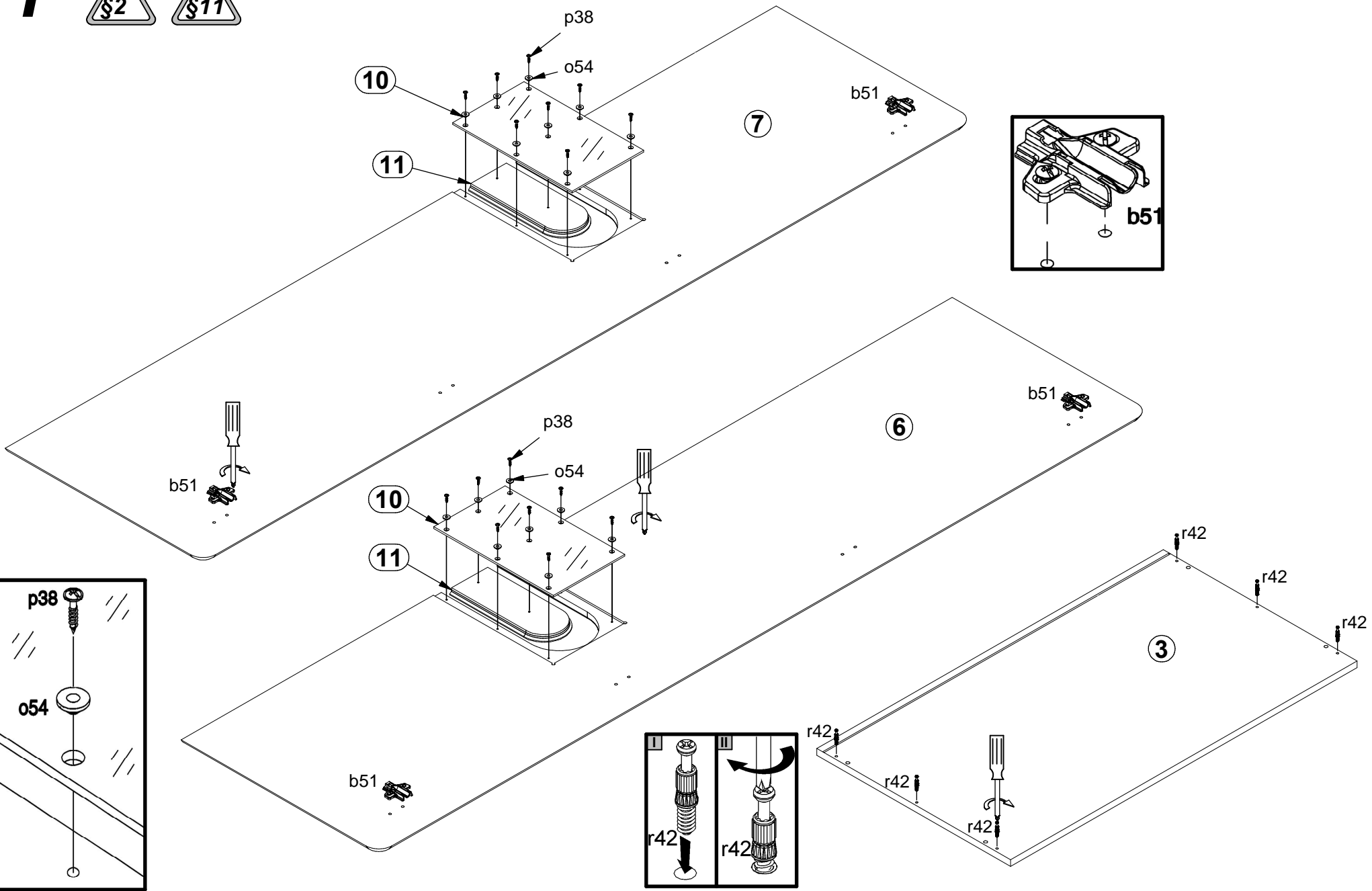



3

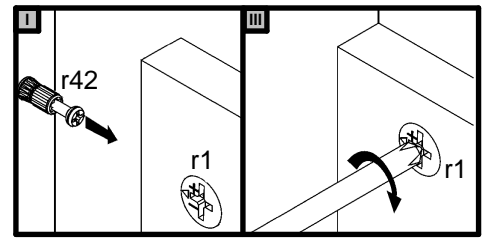

2

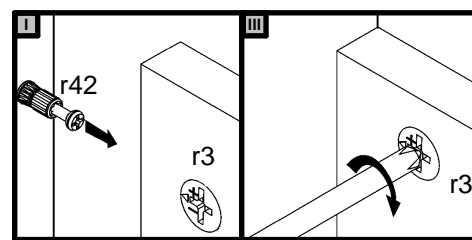
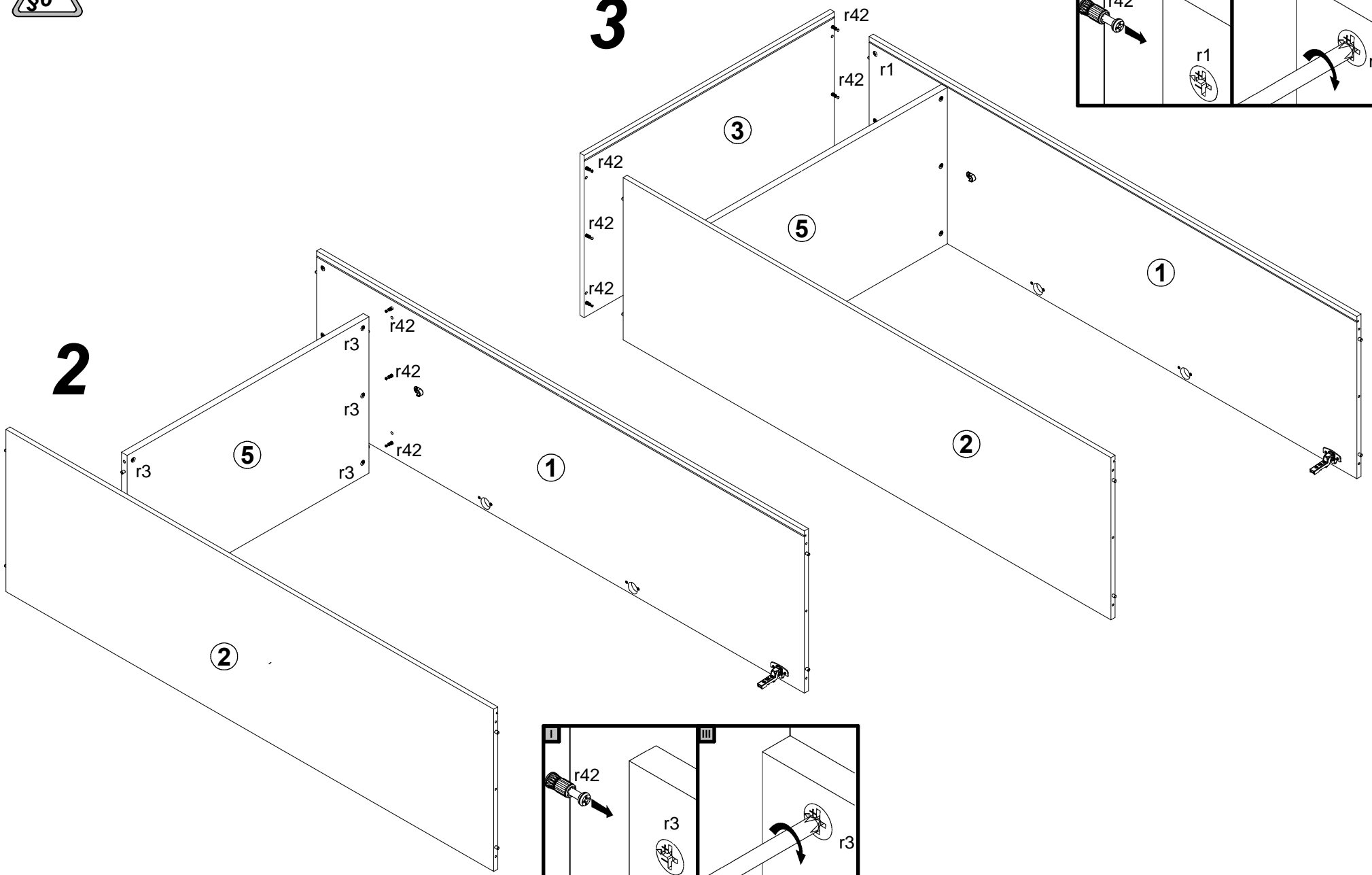

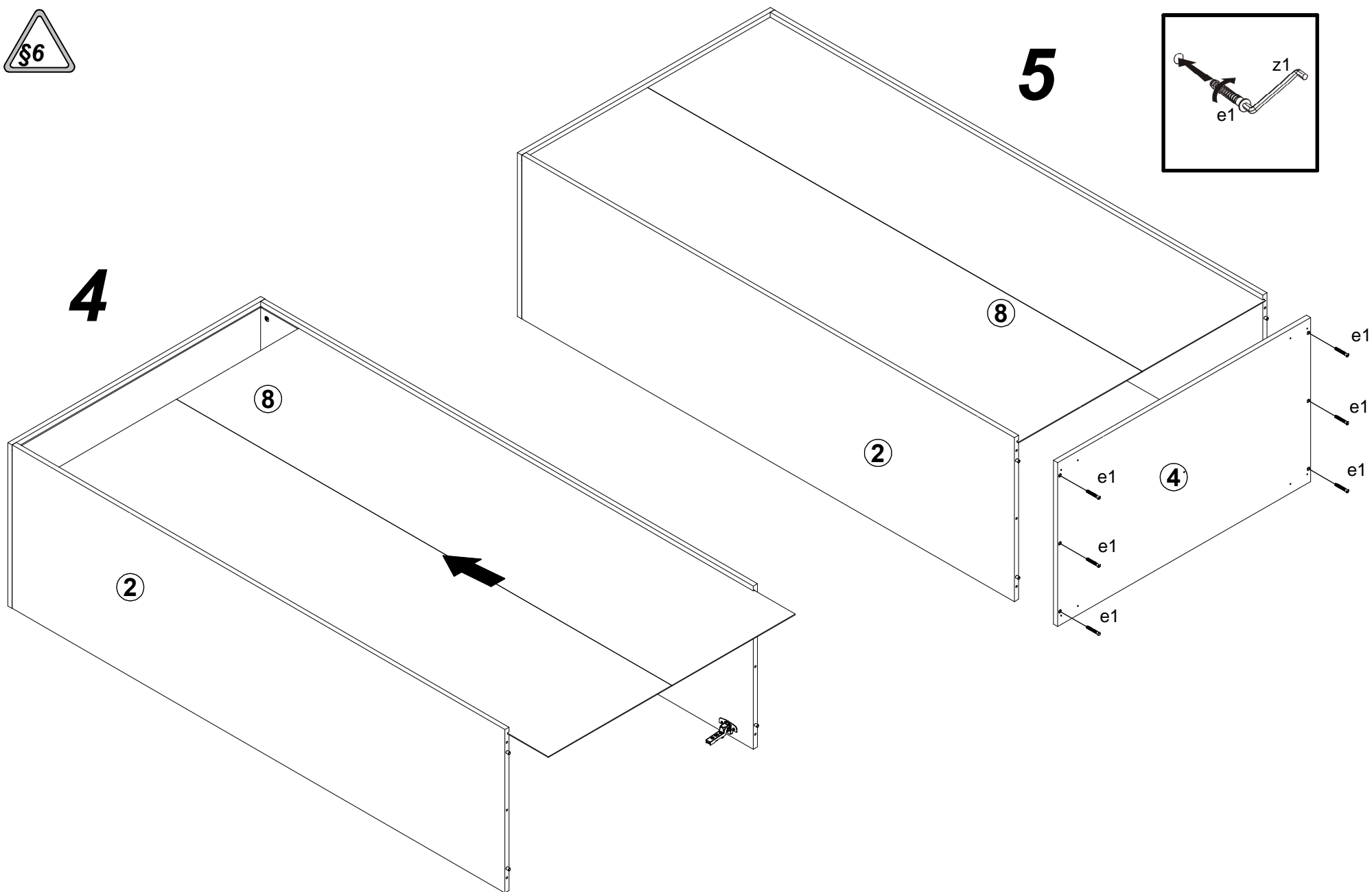

6 

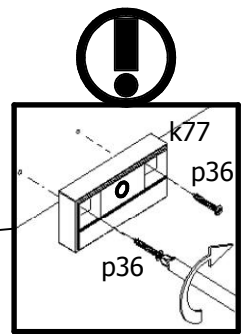
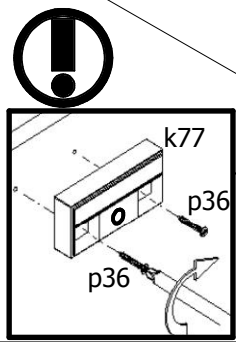
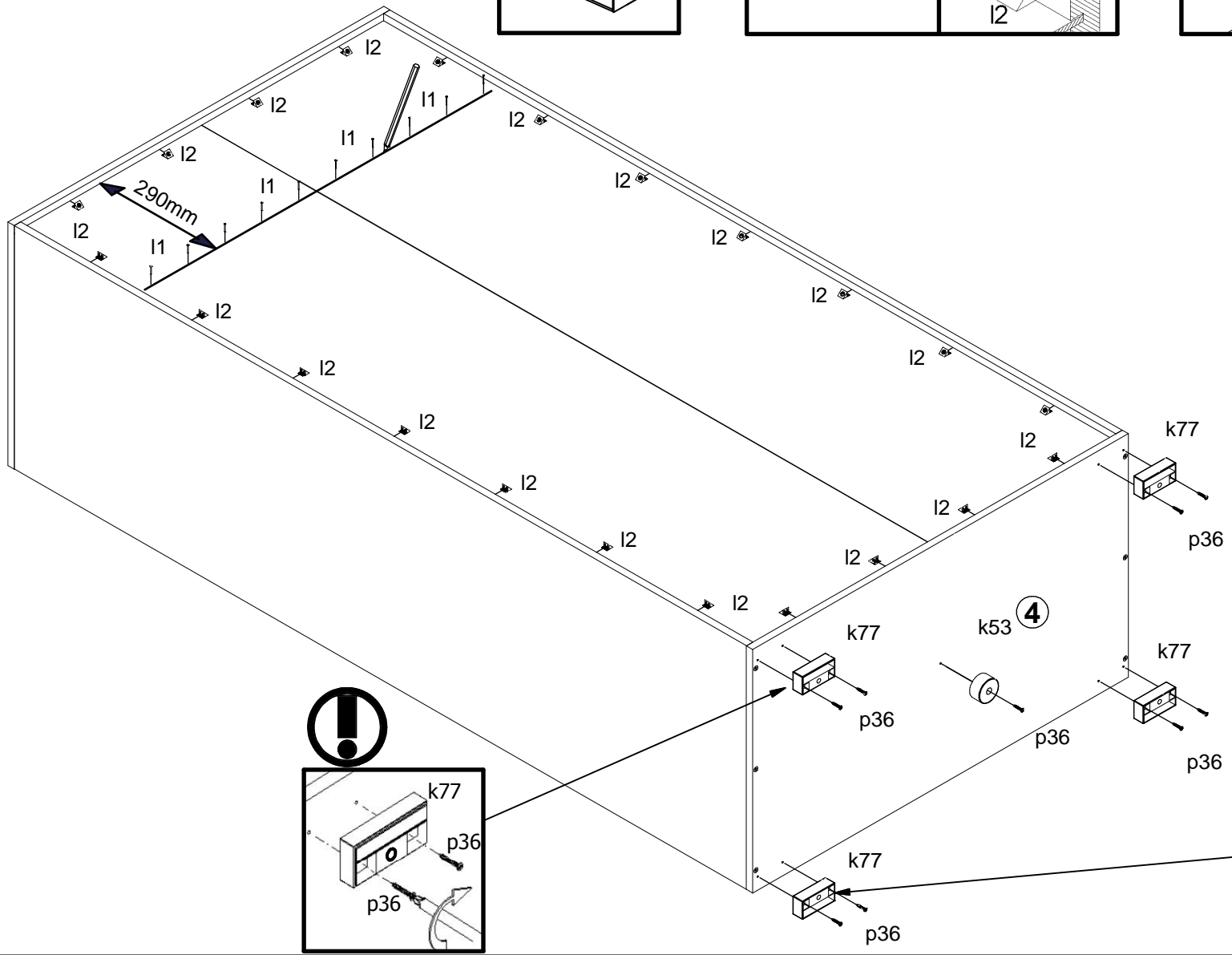
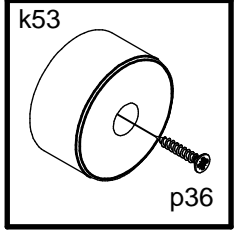
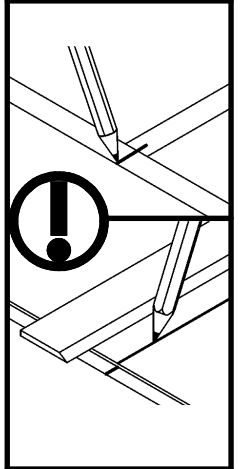
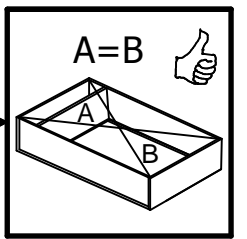
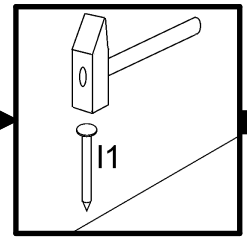
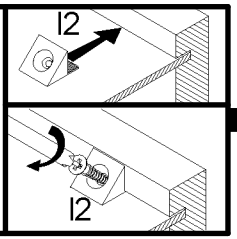
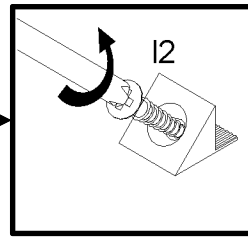
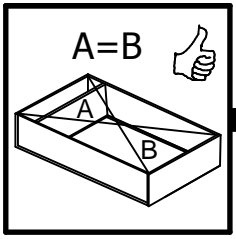

7

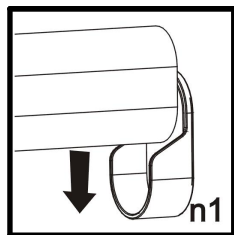
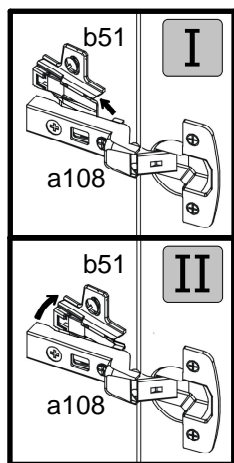
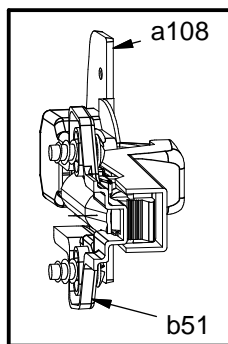
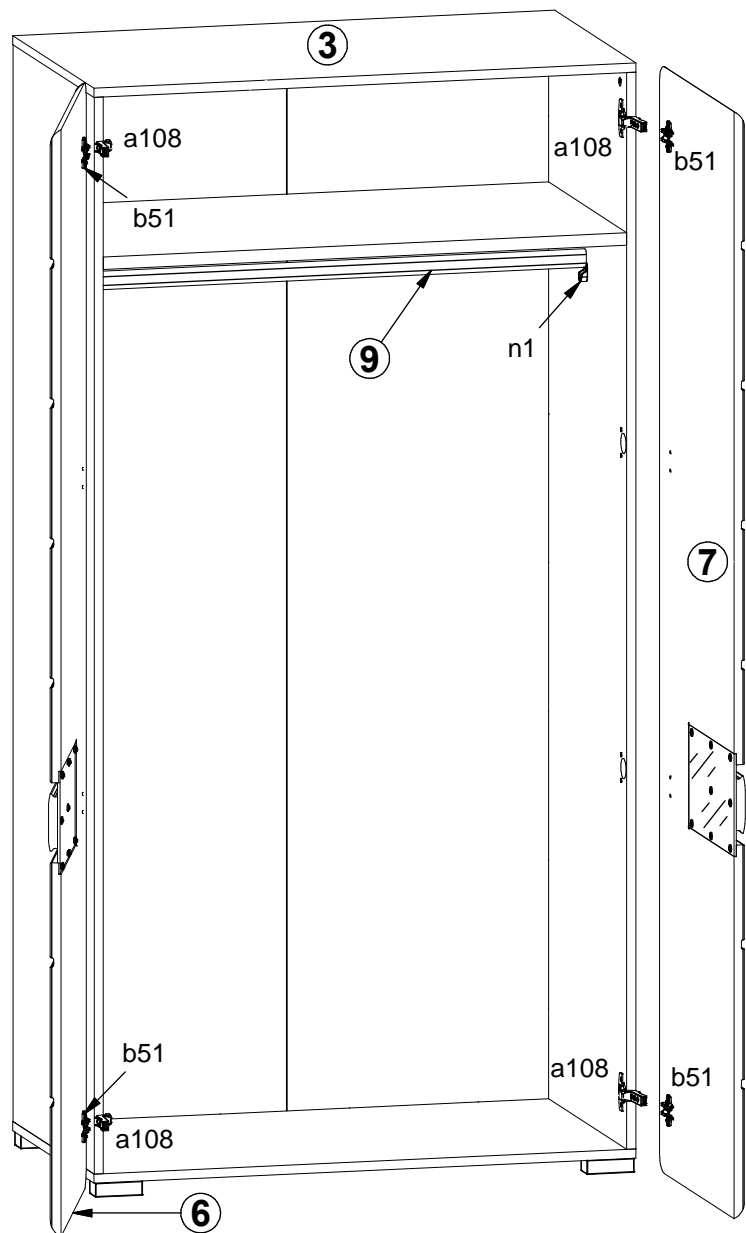

8

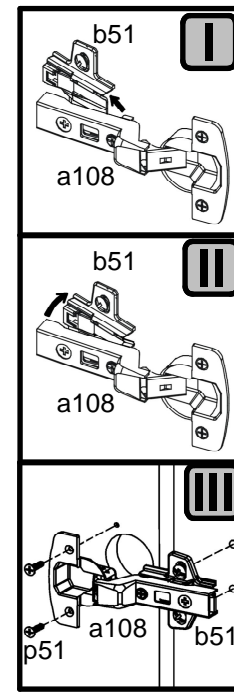
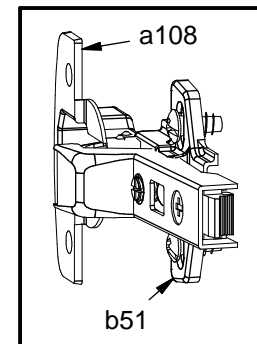
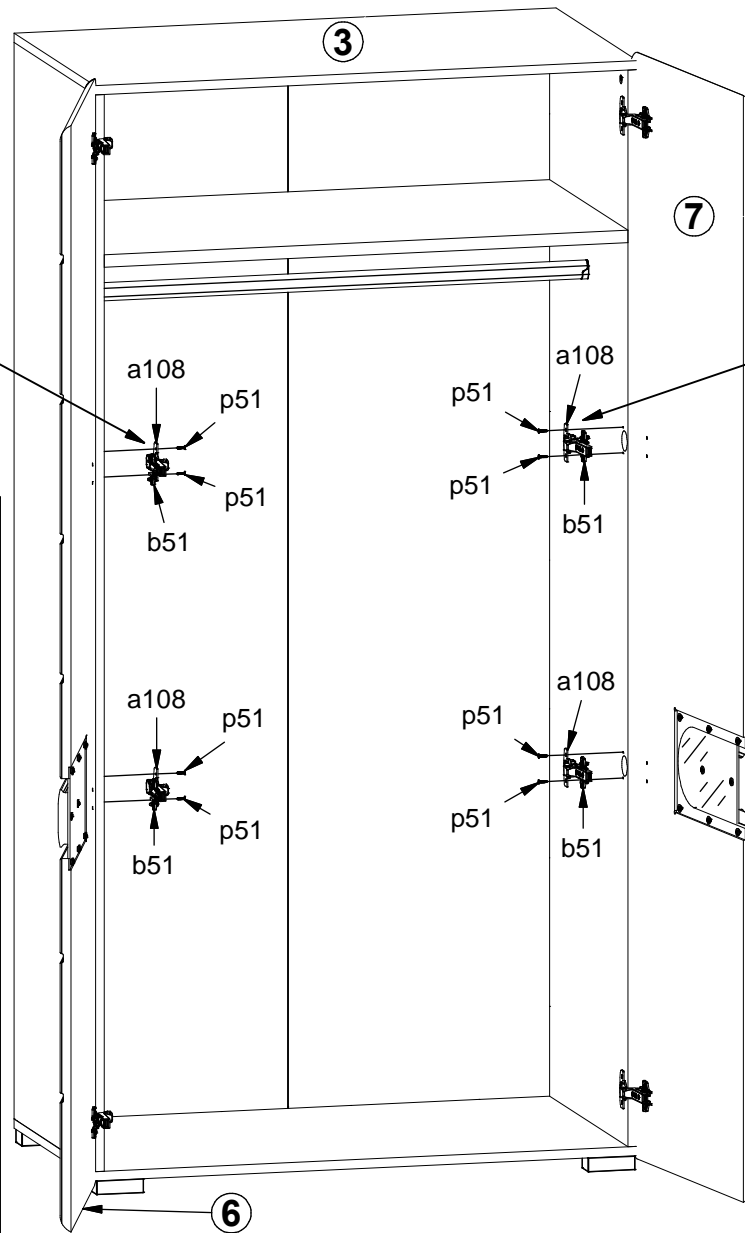

9

